



SPECIFICATION

**ISM band – 868 MHz
Fiberglass Antenna
(3~4 dBi)**



Model No. : AF01LW-8-S9-174-3-S0



1. General Description

1.1 Electrical Properties

Parameter	Description
Frequency Band	868 MHz
Nominal Impedance	50 Ω
Polarization	Vertical
V.S.W.R.	1.05 : 1
Max. Power	100 W

1.2 Mechanical Properties

Parameter	Description
Dimensions	756 mm \pm 10
Antenna Connector	180° N Female
Cable Length	RG-174*3000 mm \pm 30
Cable Connector	180° N Male / 180° SMA Male
Operating Temperature	-20°C~+60°C
Storage Temperature	-30°C~+70°C
Accessory	Mounting kit * 1

2. Appearance (Unit : mm)

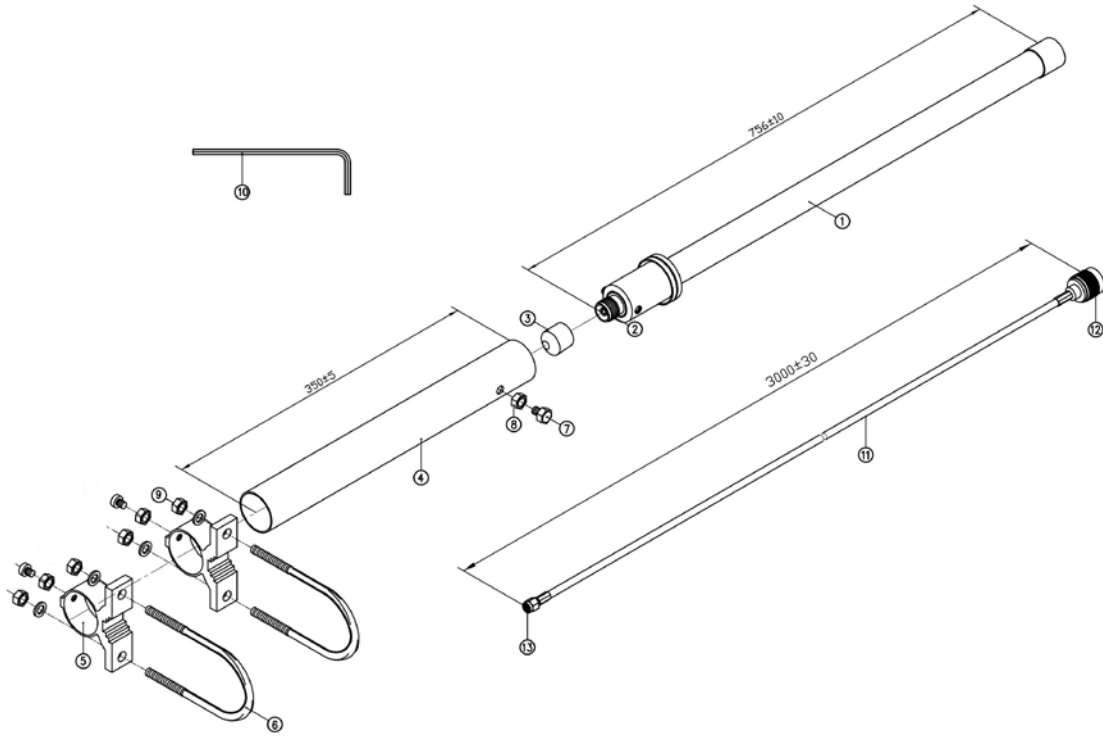

NO.	Name	Finish
1	Fiberglass body	White
2	180° N Female	Nickel plating
11	RG-174 cable	Black
12	180° N Male	Nickel plating
13	180° SMA Male	Nickel plating
Mounting Accessories		
3	Cap	Black
4	Mast	Aluminium
5	Clamp	Aluminium
6	U-bolt	Stainless steel
7	Screw	Stainless steel
8	Hexagonal nut	Stainless steel
9	Washer	Stainless steel
10	Hexagonal tool	Iron



3. Performance

3.1 Return Loss

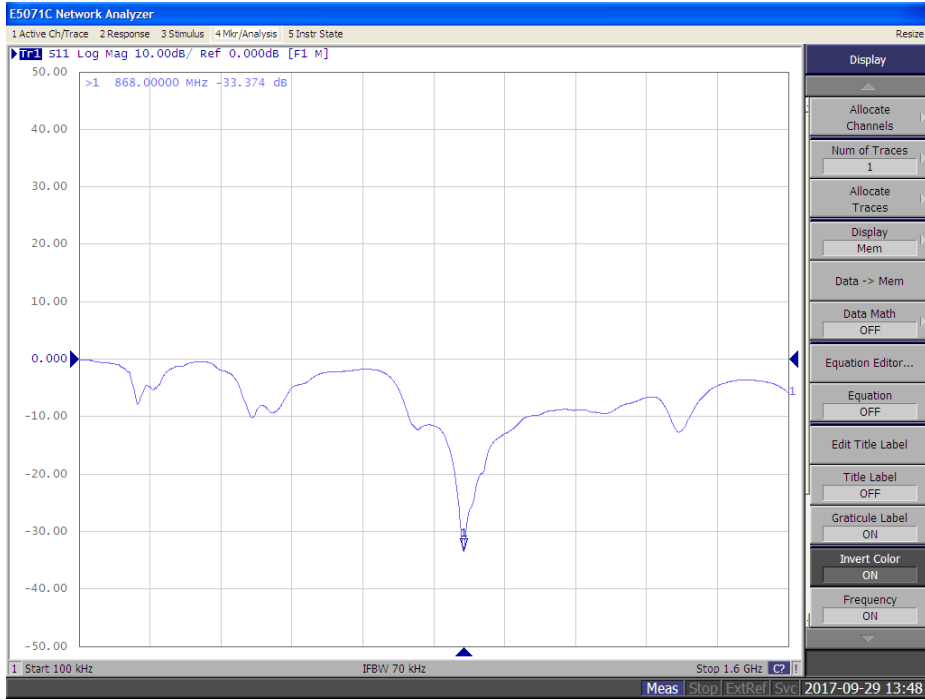

3.2 V.S.W.R.

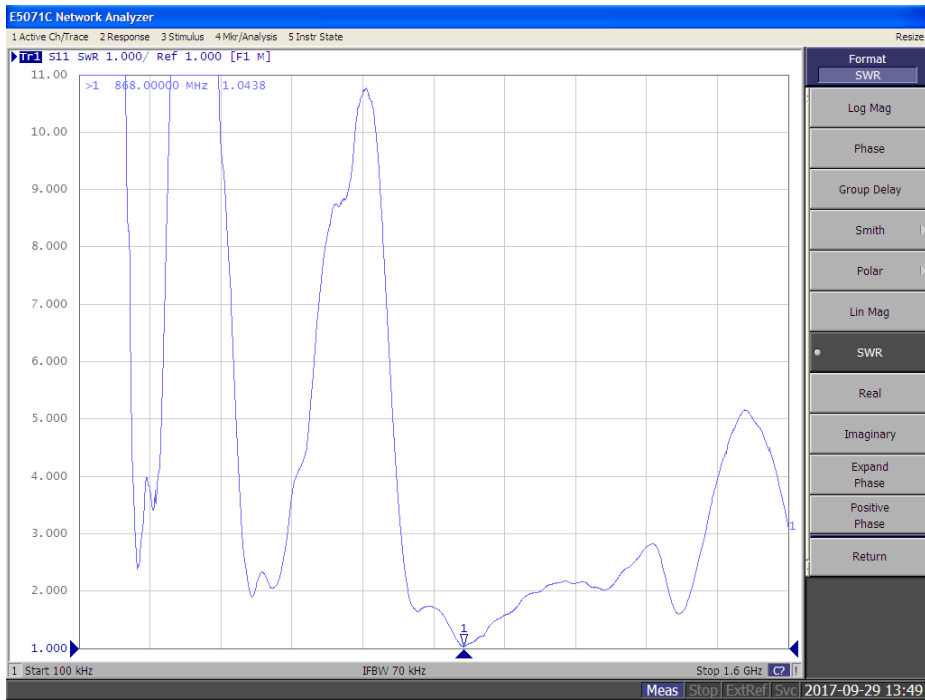

3.3 Smith Chart

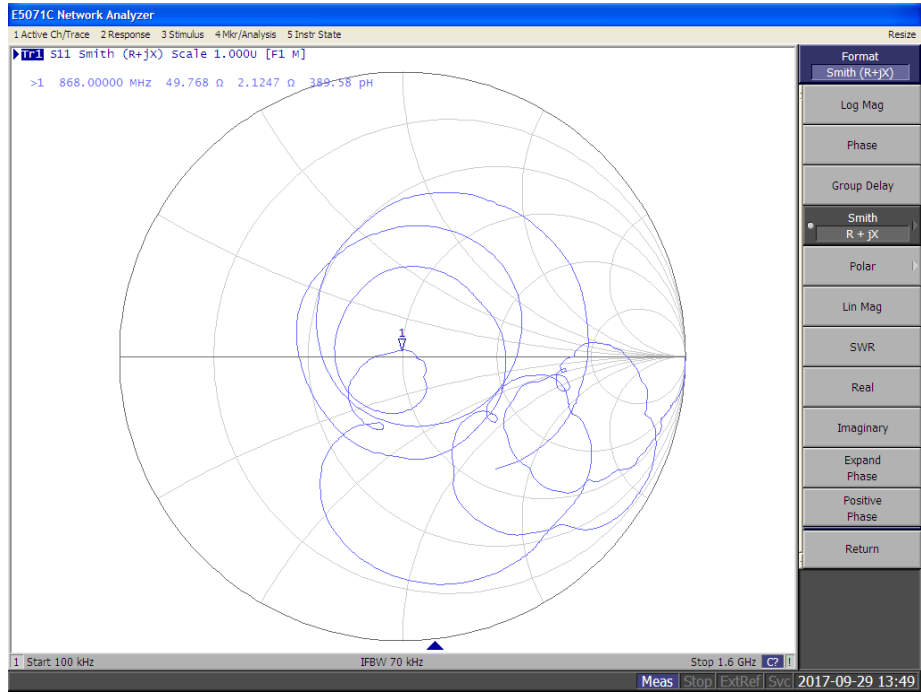



3.4 Efficiency & Gain

Frequency (MHz)	858	868	878
Efficiency (%)	57.94	63.83	60.95
Gain (dBi)	2.79	3.96	4.22

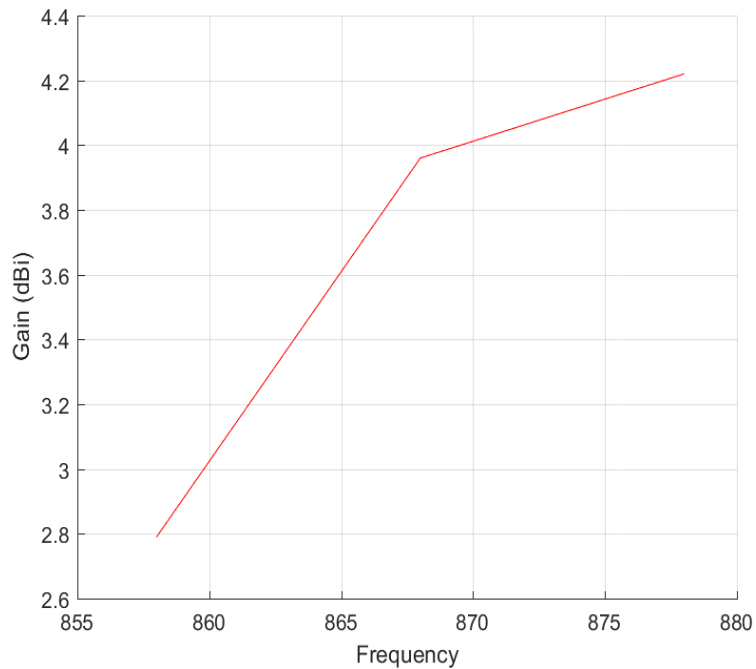
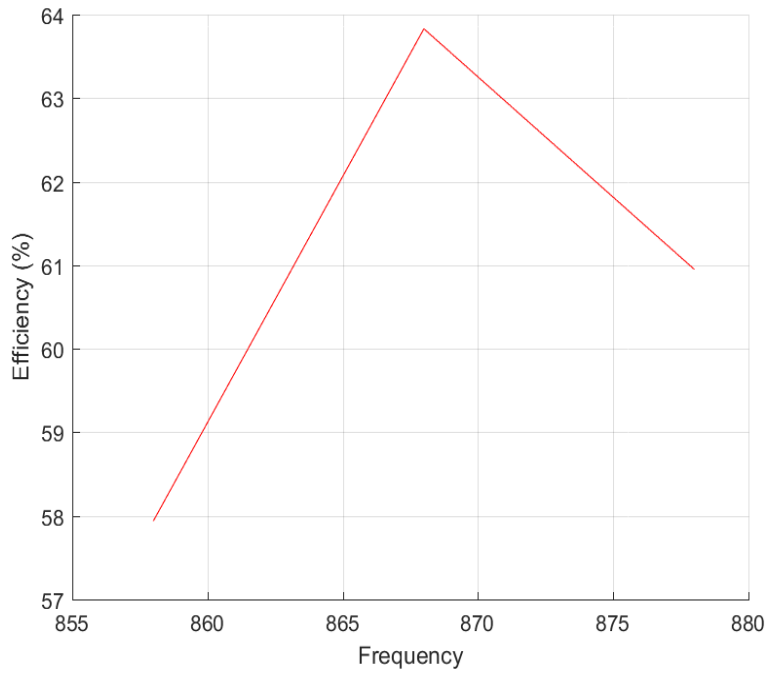

3.5 2D Radiation Pattern

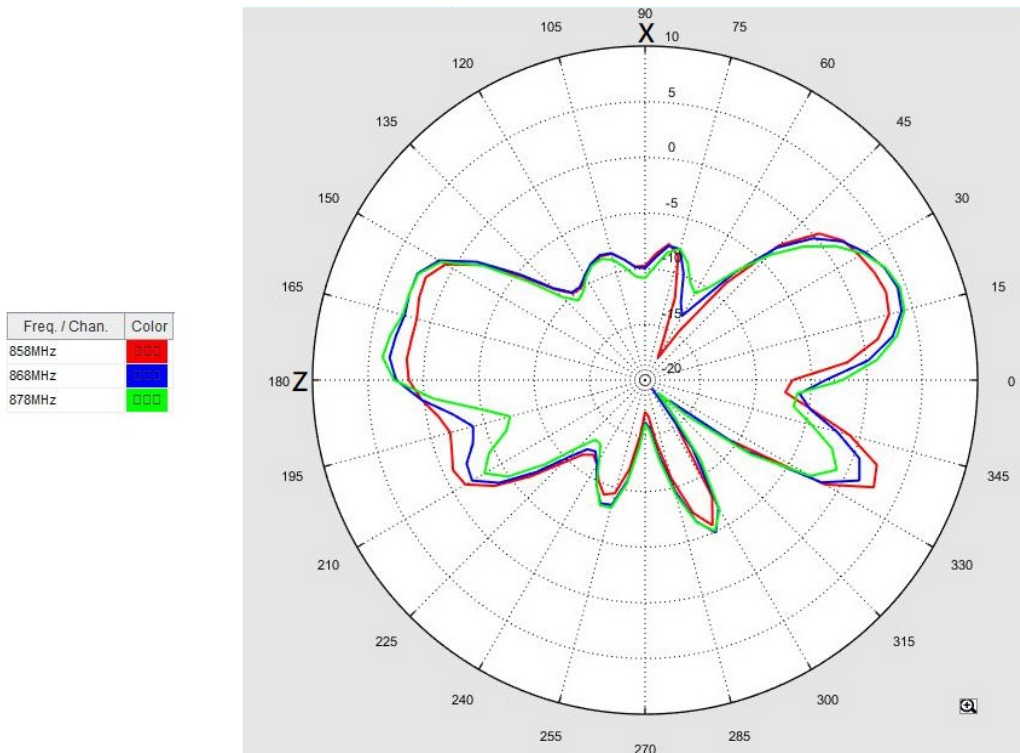

3.6 3D Radiation Pattern

Total_3D_Side View 1_858MHz

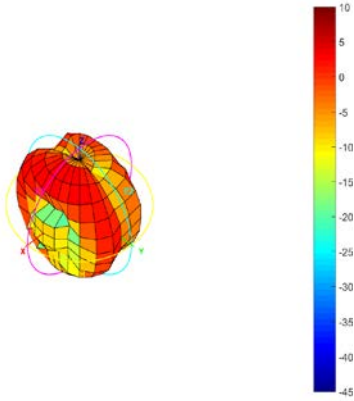

Total_3D_Side View 2_858MHz

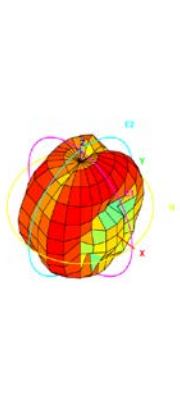

Total_3D_Side View 3_858MHz

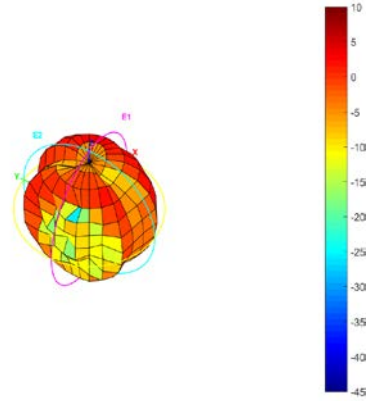

Total_3D_Side View 1_868MHz

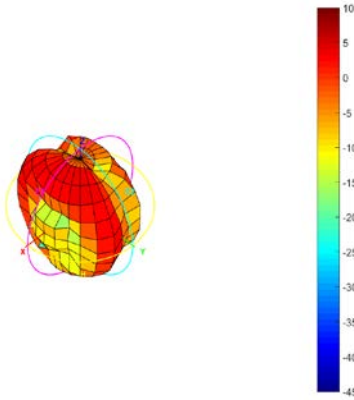

Total_3D_Side View 2_868MHz

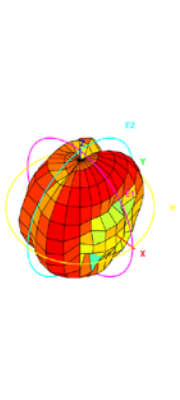

Total_3D_Side View 3_868MHz

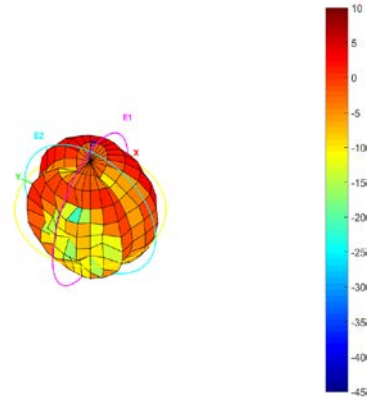

Total_3D_Side View 1_878MHz

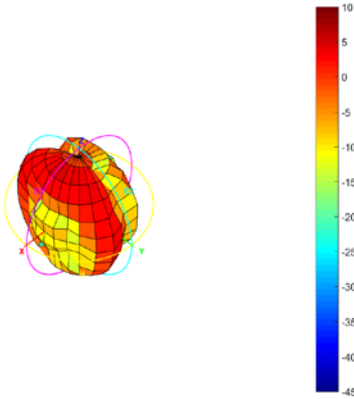

Total_3D_Side View 2_878MHz

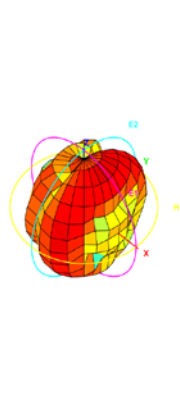

Total_3D_Side View 3_878MHz

