

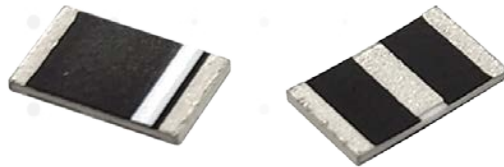

SPECIFICATION

**ISM band – 868 MHz
Chip Antenna**



Model No. : UTCLW-801



1. General Description

1.1 Electrical Properties

Parameter		Description
Frequency Band		863~871 MHz
Nominal Impedance		50 Ω
Polarization		Linear
V.S.W.R.		<2:1
Efficiency	@ 868 MHz	47 %
Peak Gain		0 dBi
※With 80 x 40 mm Evaluation Board		

1.2 Mechanical Properties

Parameter	Description
Dimensions	5*3*0.5 mm
Operating Temperature	-40°C~85°C
Storage Temperature (With Packing Sealed)	-5°C~40°C

2. Appearance

2.1 Dimensions Of Antenna And Evaluation Board (Unit : mm)

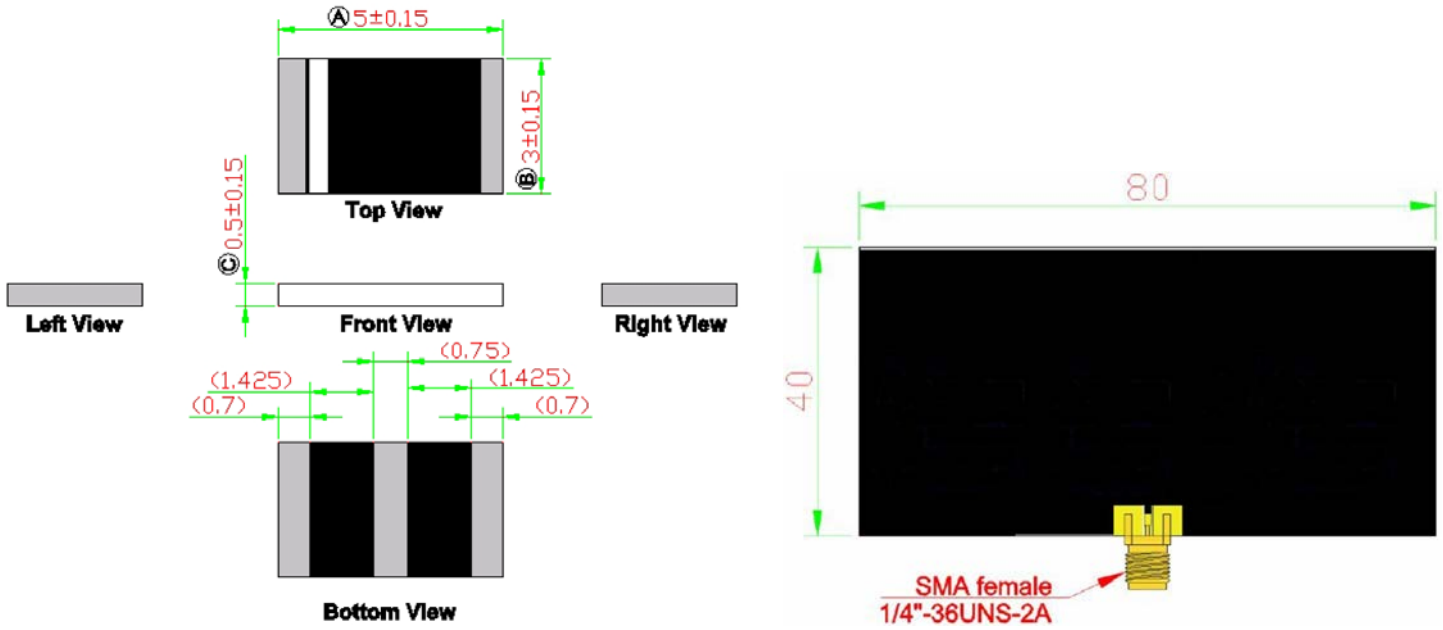

2.2 PIN Definitions

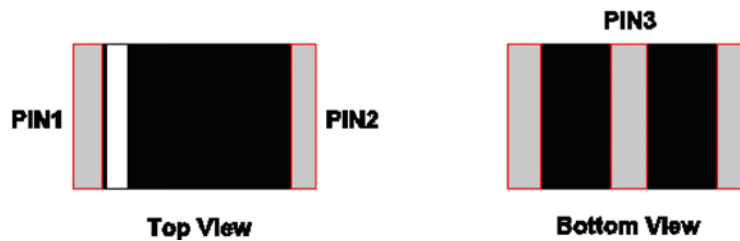

Item	PIN 1	PIN 2	PIN 3
Terminal	Signal	Tuning / Ground	Soldering Pad

3. Layout Guide (Unit : mm)

The solder land pattern (yellow marking areas) is shown as below.
 Recommendation on matching circuit will be provided according to customer's installation conditions.

With 80 x 40 mm Evaluation Board

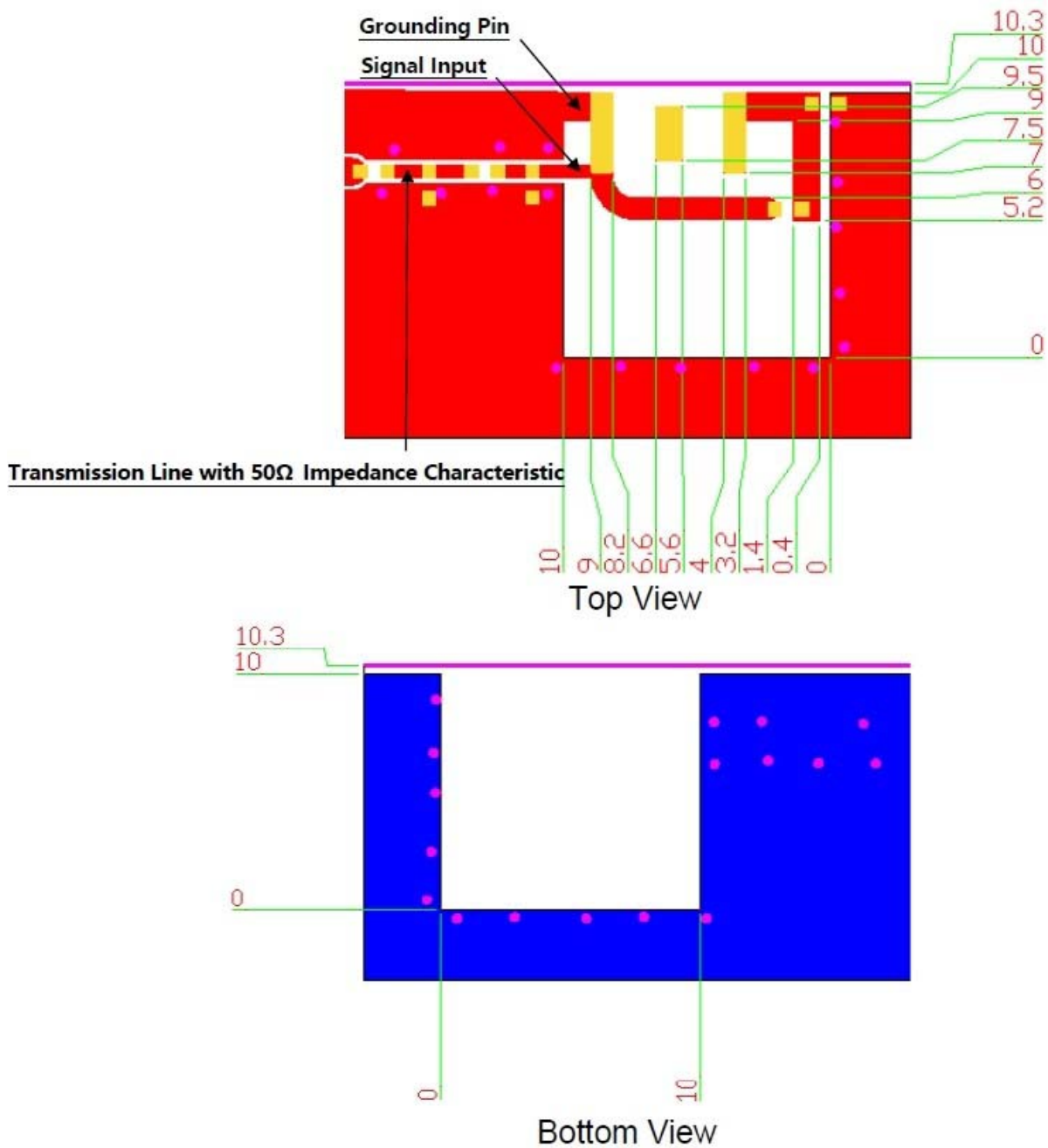

4. Frequency Tuning And Matching Circuit

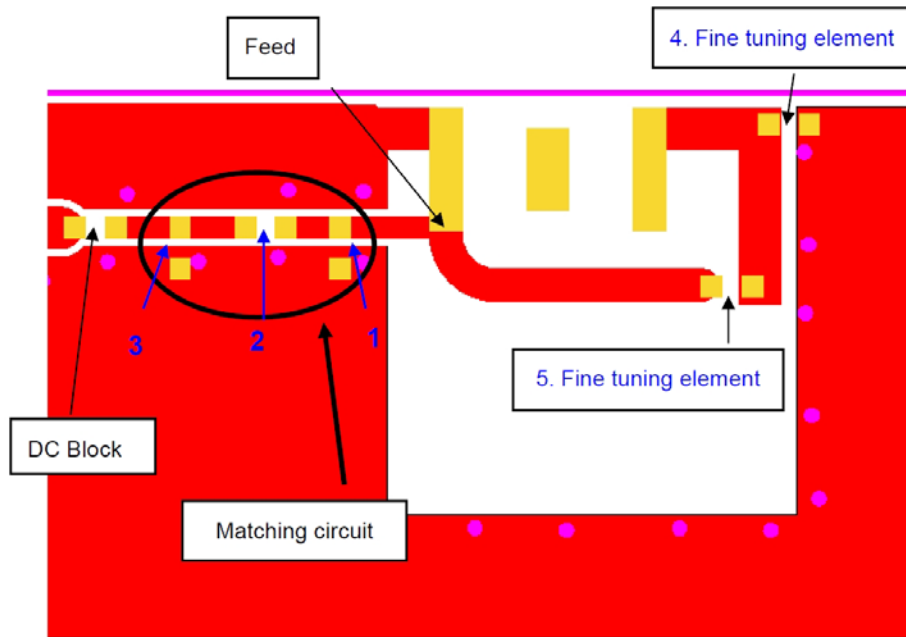

With the following recommended values of matching and tuning components, the center frequency will be about 868 MHz at our standard 80x40 mm evaluation board.

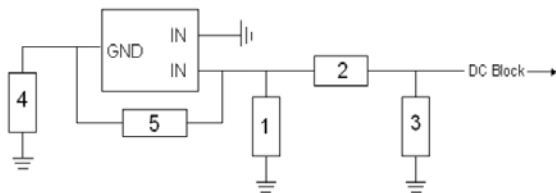

System Matching Circuit Component			
Location	Description	Vendor	Tolerance
1	N/A*	-	-
2	4.7nH*, 0402	MURATA	±0.3nH
3	4.3pF*, 0402	MURATA	±0.05pF
DC Block	22pF*, 0402	MURATA	±5%
Fine tuning element 4	3.3pF*, 0402	MURATA	±0.05pF
Fine tuning element 5	3.9pF*, 0402	MURATA	±0.05pF

※These are typical reference values which may need to be changed when circuit boards or part vendors are different.

5. Soldering Conditions

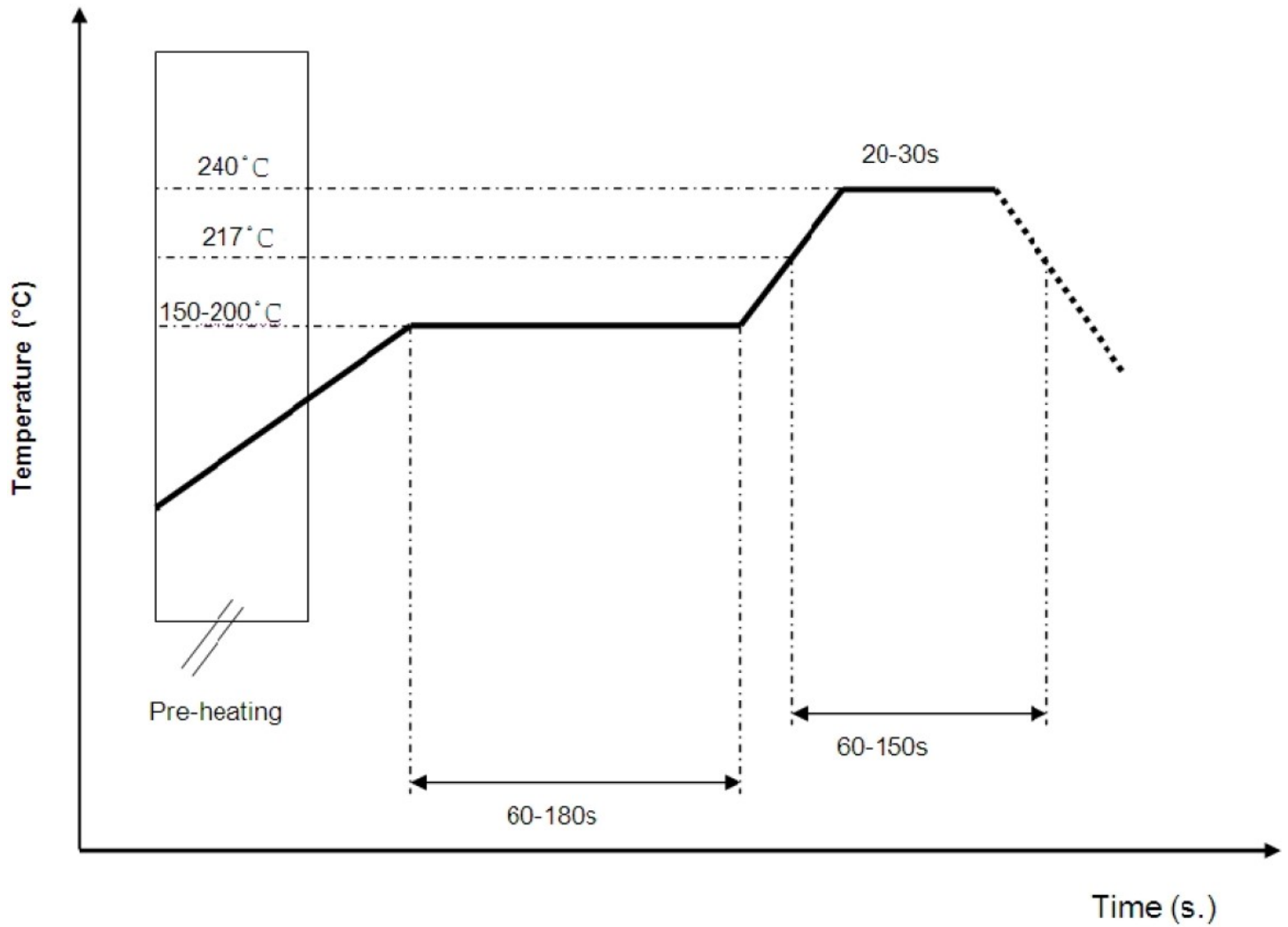

※Recommended solder paste alloy : SAC305(Sn96.5/Ag3/Cu0.5) Lead free solder paste.



6. Performance

6.1 V.S.W.R. , Average Gain , Peak Gain

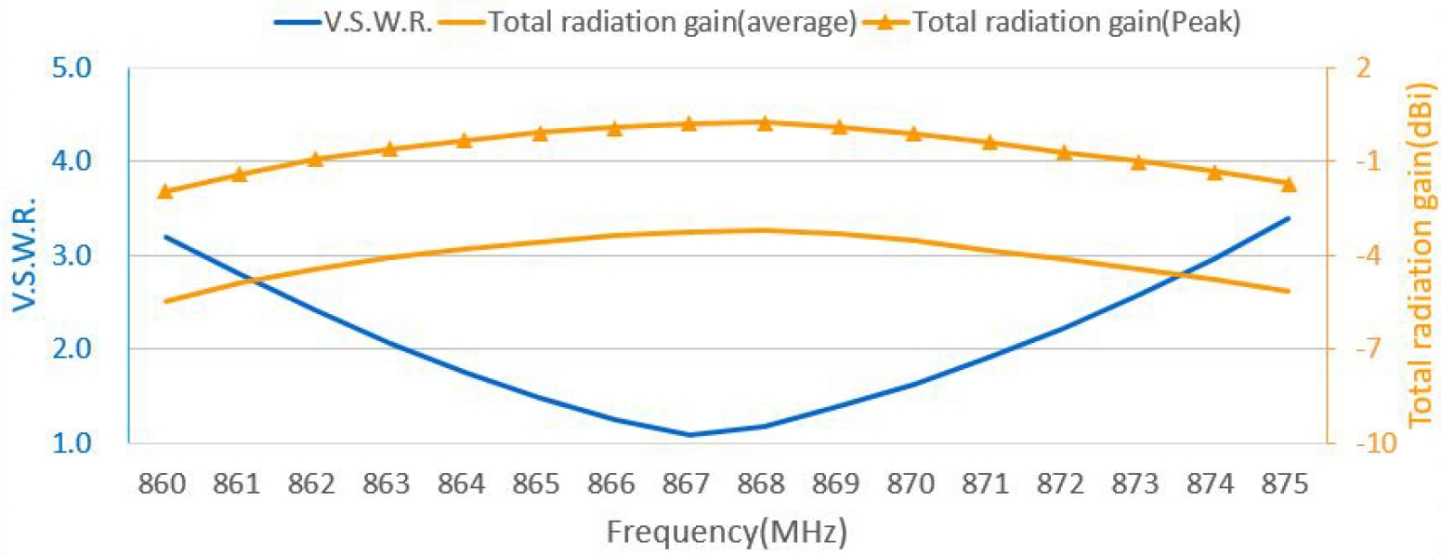

6.2 3D Radiation Pattern

3D Gain Pattern @ 868 MHz (Unit : dBi)

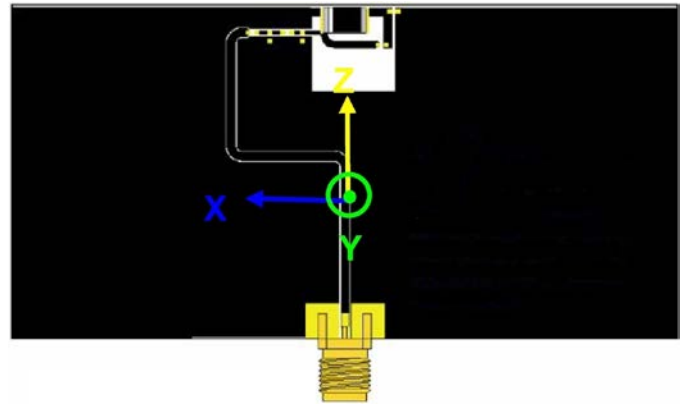
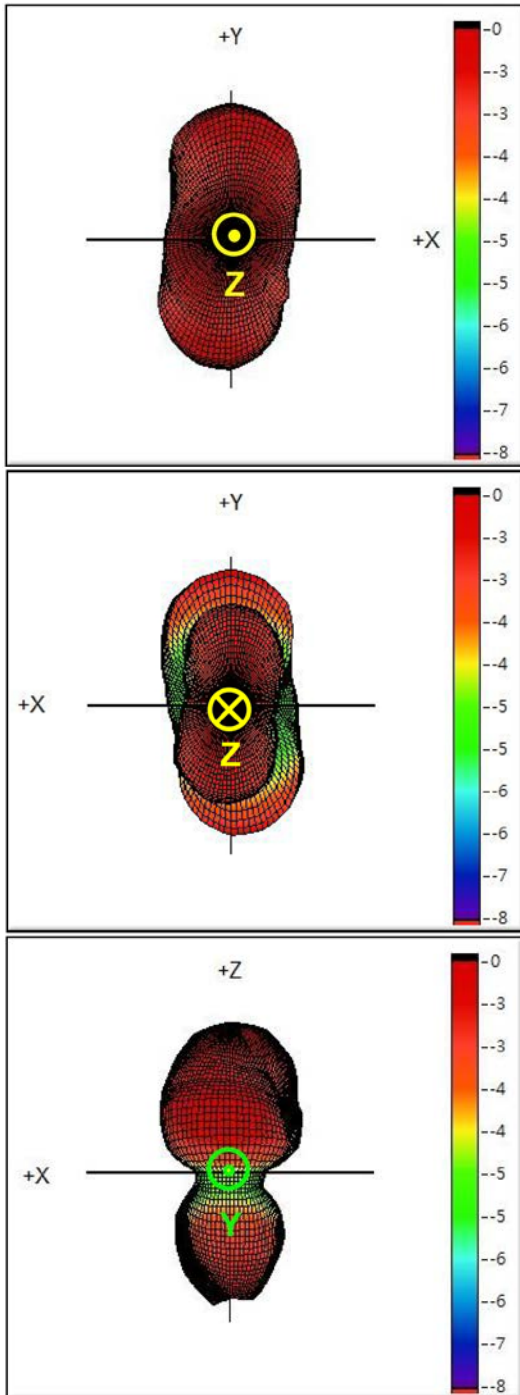

7. Packing

- Tape :

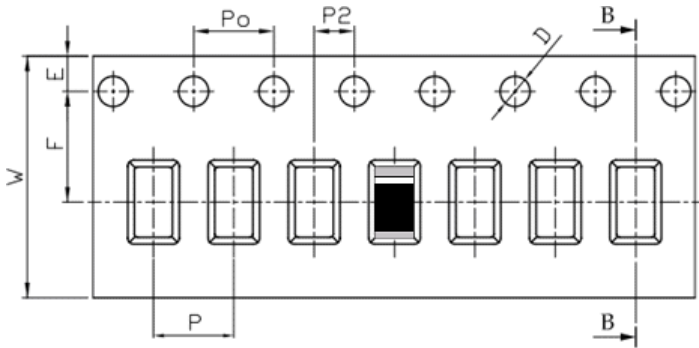

Feature	Specifications	Tolerances
W	12.00	±0.30
P	4.00	±0.10
E	1.75	±0.10
F	5.50	±0.10
P2	2.00	±0.10
D	1.50	+0.10 -0.00
Po	4.00	±0.10
10Po	40.00	±0.20

- Reel : 6,000 pcs

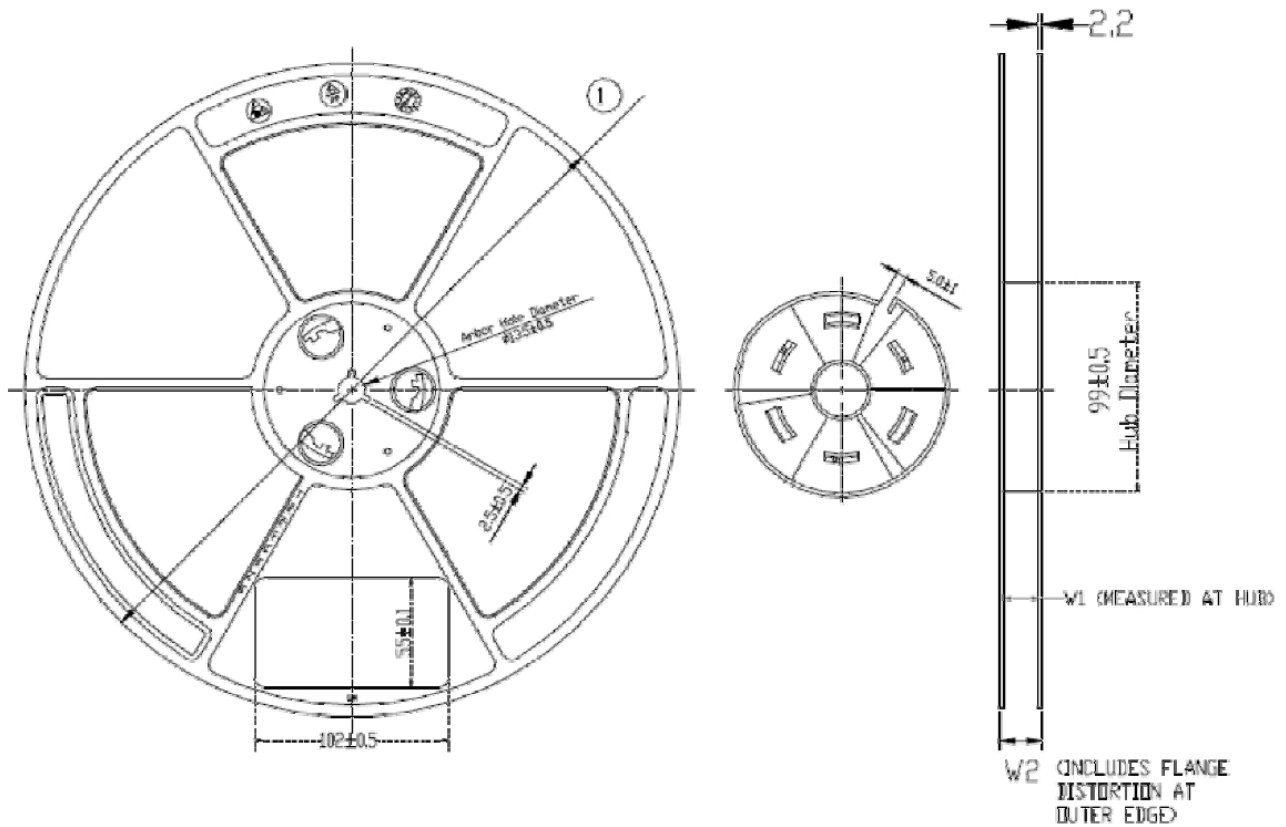

① Diameter	W1	W2
330±1mm	13.4±1mm	17.8±1mm