



# SPECIFICATION

**ISM band – 868 MHz  
Fiberglass Antenna  
( 3~4 dBi )**



**Model No. : AF01LW-8-S9-174-3-S0**



## 1. General Description

### 1.1 Electrical Properties

Parameter	Description
Frequency Band	868 MHz
Nominal Impedance	50 $\Omega$
Polarization	Vertical
V.S.W.R.	1.05 : 1
Max. Power	100 W

### 1.2 Mechanical Properties

Parameter	Description
Dimensions	756 mm $\pm$ 10
Antenna Connector	180° N Female
Cable Length	RG-174*3000 mm $\pm$ 30
Cable Connector	180° N Male / 180° SMA Male
Operating Temperature	-20°C~+60°C
Storage Temperature	-30°C~+70°C
Accessory	Mounting kit * 1

## 2. Appearance (Unit : mm)

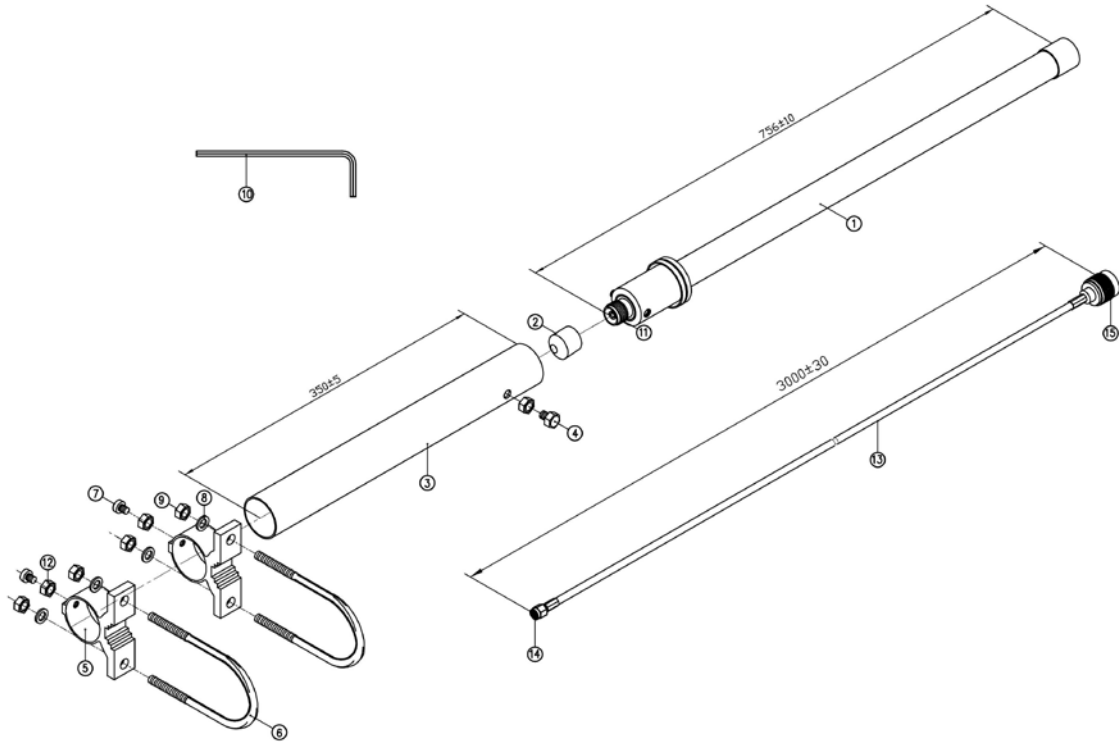

NO.	Name	Finish
1	Fiberglass body	White
2	Cap	Black
<b>Mounting Accessories</b>		
3	Mast	Aluminium
4 & 7	Screw	Stainless steel
5	Clamp	Aluminium
6	U-bolt	Stainless steel
8	Washer	Stainless steel
9 & 12	Hexagonal nut	Stainless steel
10	Hexagonal tool	Iron
11	N Female	Nickel plating
13	RG-174 cable	Black
14	SMA Male	Nickel plating
15	N Male	Nickel plating



### 3. Performance

#### 3.1 Return Loss

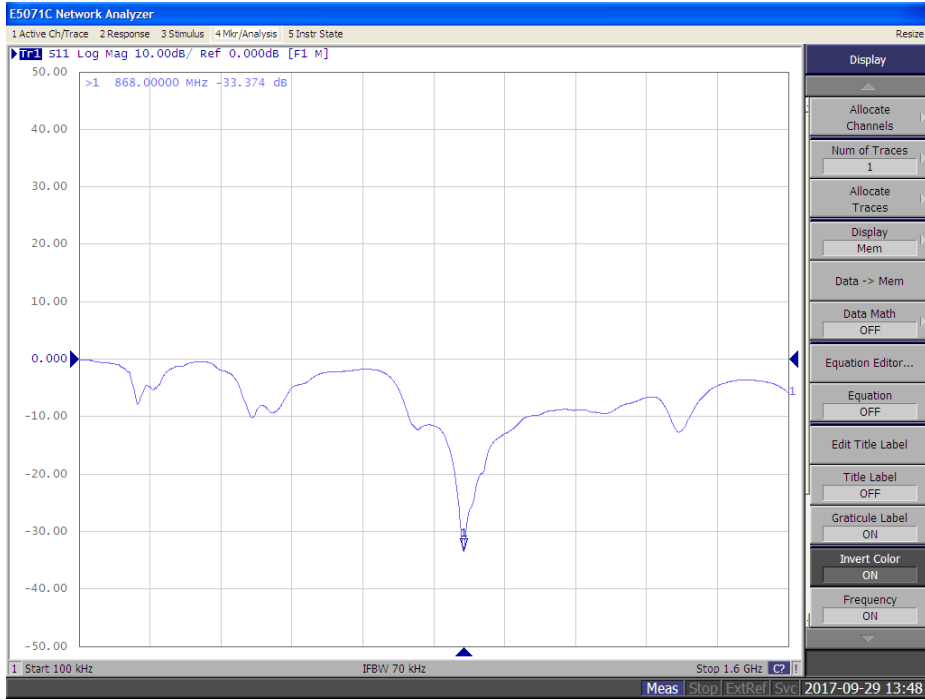

#### 3.2 V.S.W.R.

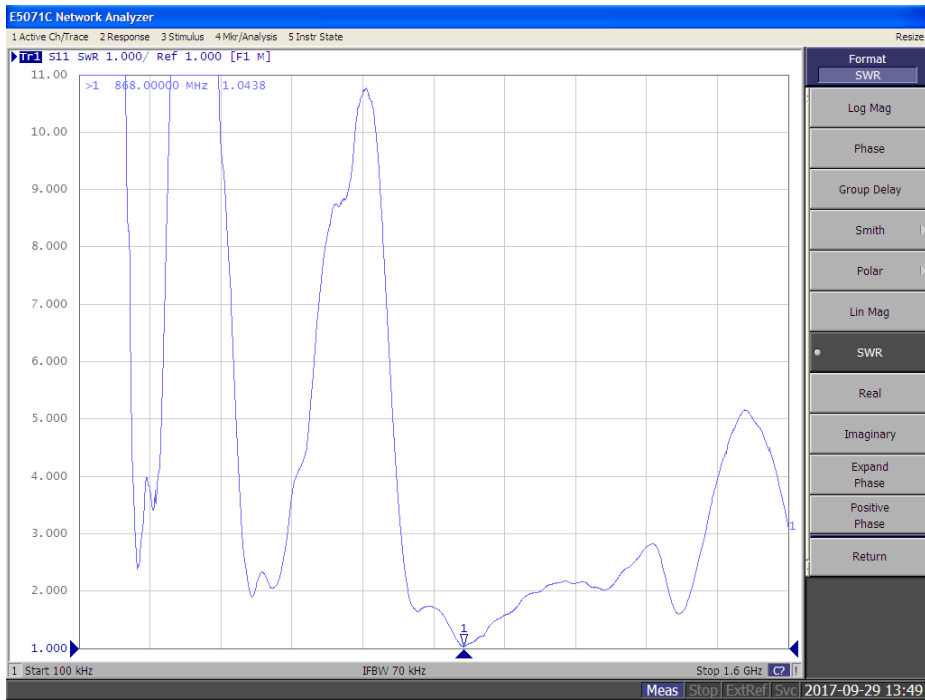

### 3.3 Smith Chart

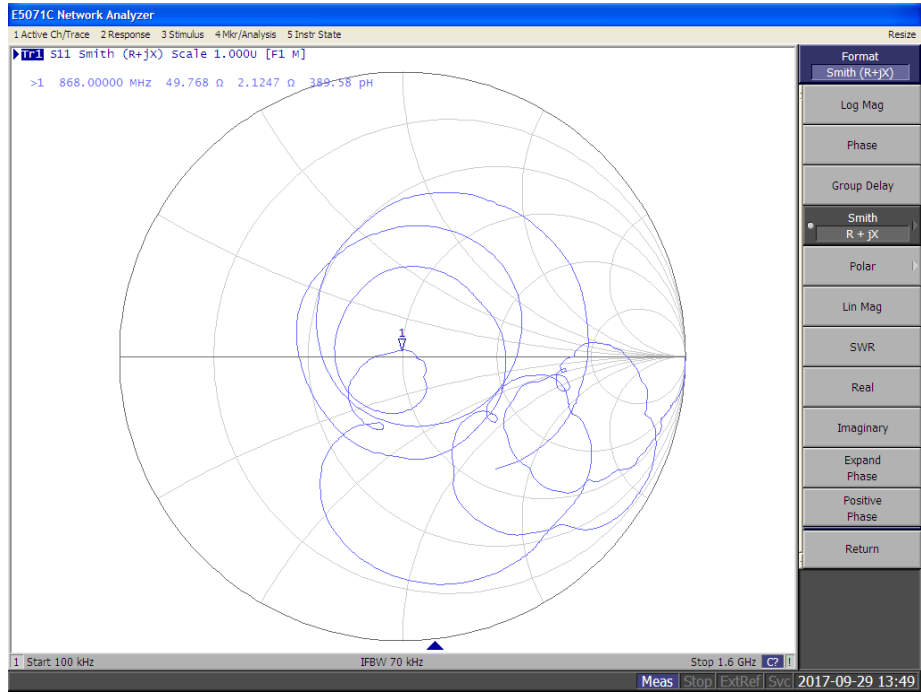



### 3.4 Efficiency & Gain

Frequency (MHz)	858	868	878
Efficiency (%)	57.94	63.83	60.95
Gain (dBi)	2.79	3.96	4.22

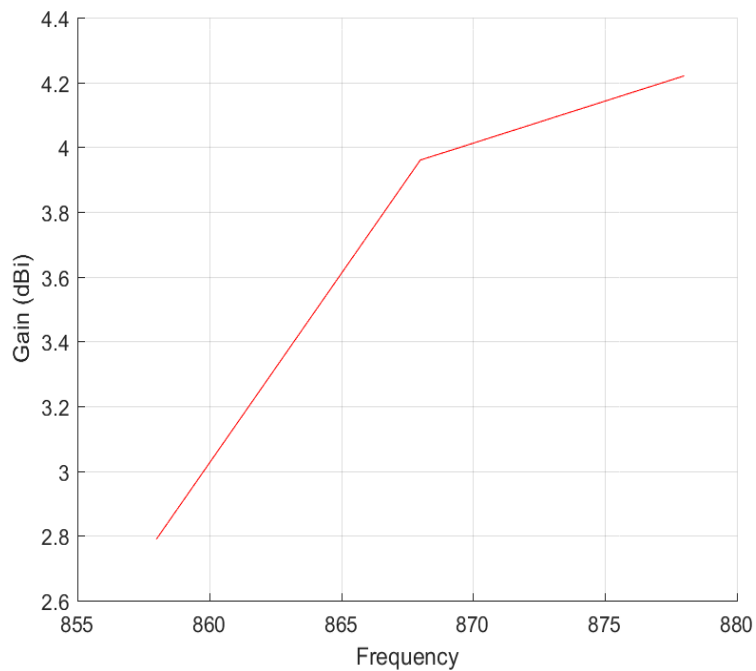
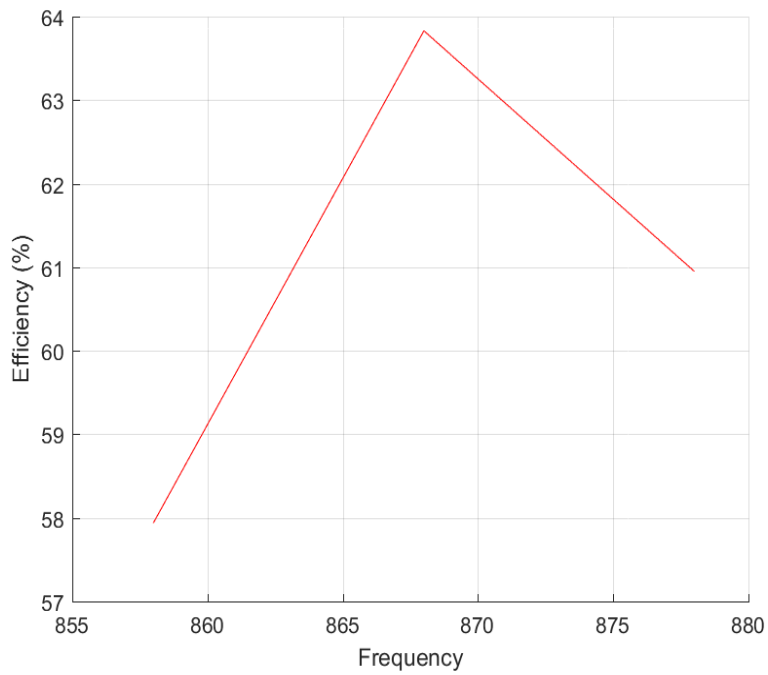

### 3.5 2D Radiation Pattern

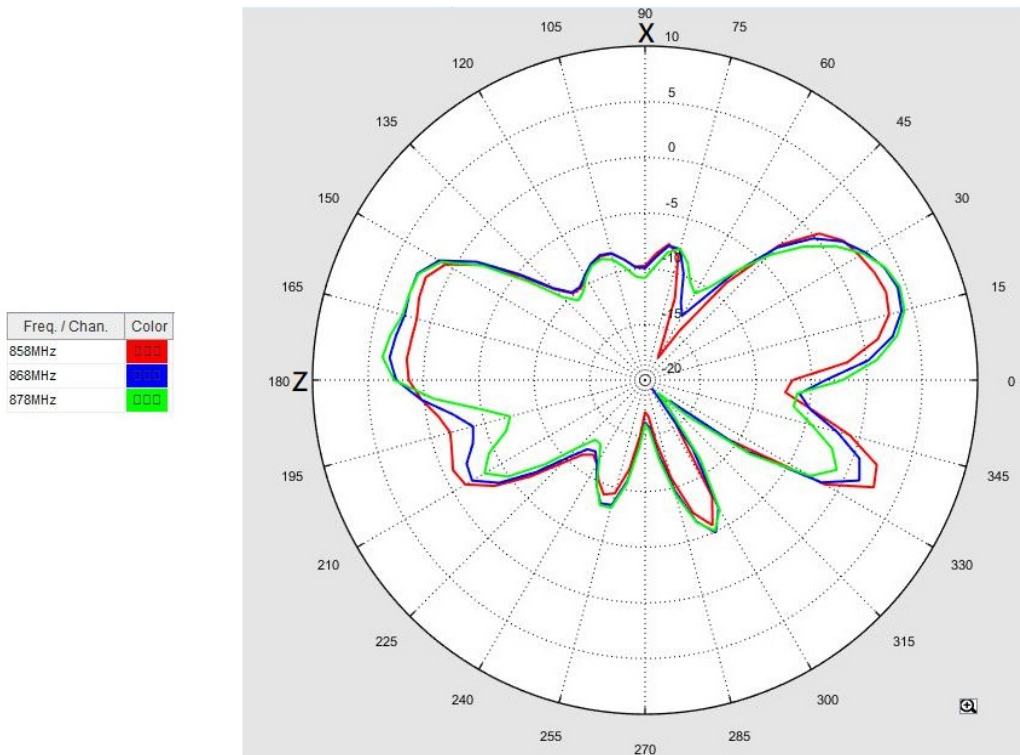

### 3.6 3D Radiation Pattern

Total\_3D\_Side View 1\_858MHz

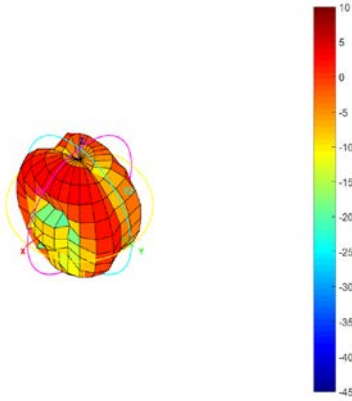

Total\_3D\_Side View 2\_858MHz

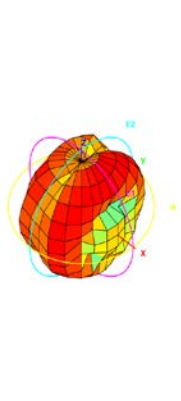

Total\_3D\_Side View 3\_858MHz

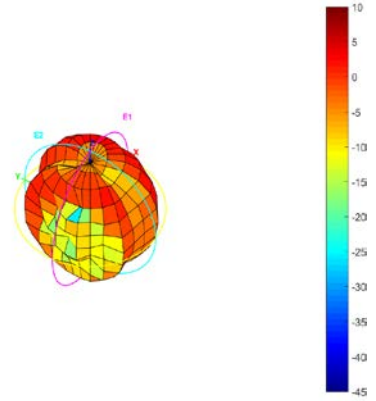

Total\_3D\_Side View 1\_868MHz

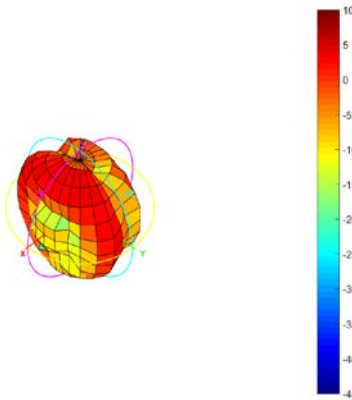

Total\_3D\_Side View 2\_868MHz

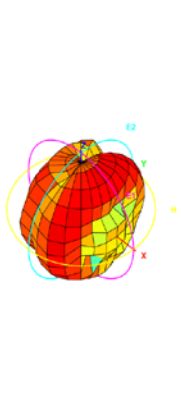

Total\_3D\_Side View 3\_868MHz

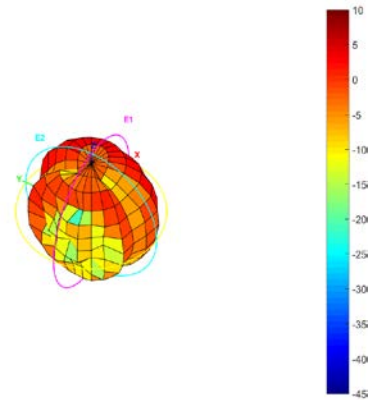

Total\_3D\_Side View 1\_878MHz

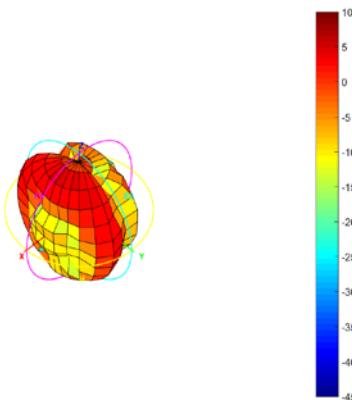

Total\_3D\_Side View 2\_878MHz

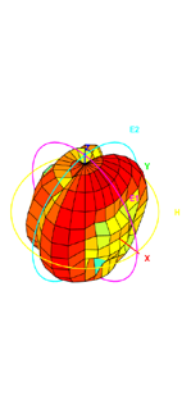

Total\_3D\_Side View 3\_878MHz

