

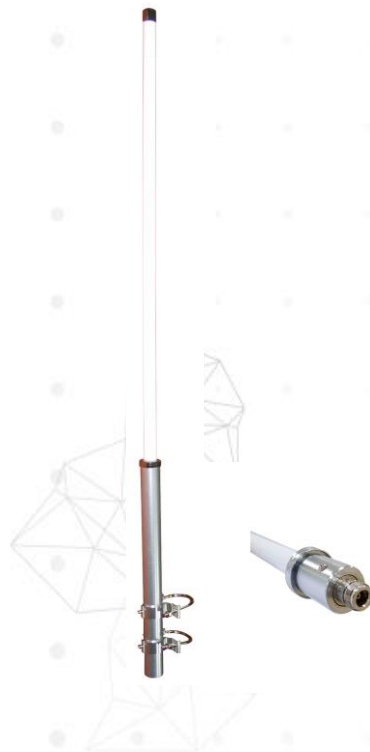

SPECIFICATION

**ISM band – 868 MHz
Fiberglass Antenna
(5~6 dBi)**



Model No. : AF04LW-8-S9-58-3-S0



1. General Description

1.1 Electrical Properties

Parameter	Description
Frequency Band	868 MHz
Nominal Impedance	50 Ω
Polarization	Vertical
V.S.W.R	1.08 : 1
Max. Power	100 W

1.2 Mechanical Properties

Parameter	Description
Dimensions	1340 mm \pm 30
Antenna Connector	180° N Female
Cable Length	RG-58*3000 mm \pm 30
Cable Connector	180° N Male / 180° SMA Male
Operating Temperature	-20°C~+60°C
Storage Temperature	-30°C~+70°C
Accessory	Mounting kit * 1

2. Appearance (Unit : mm)

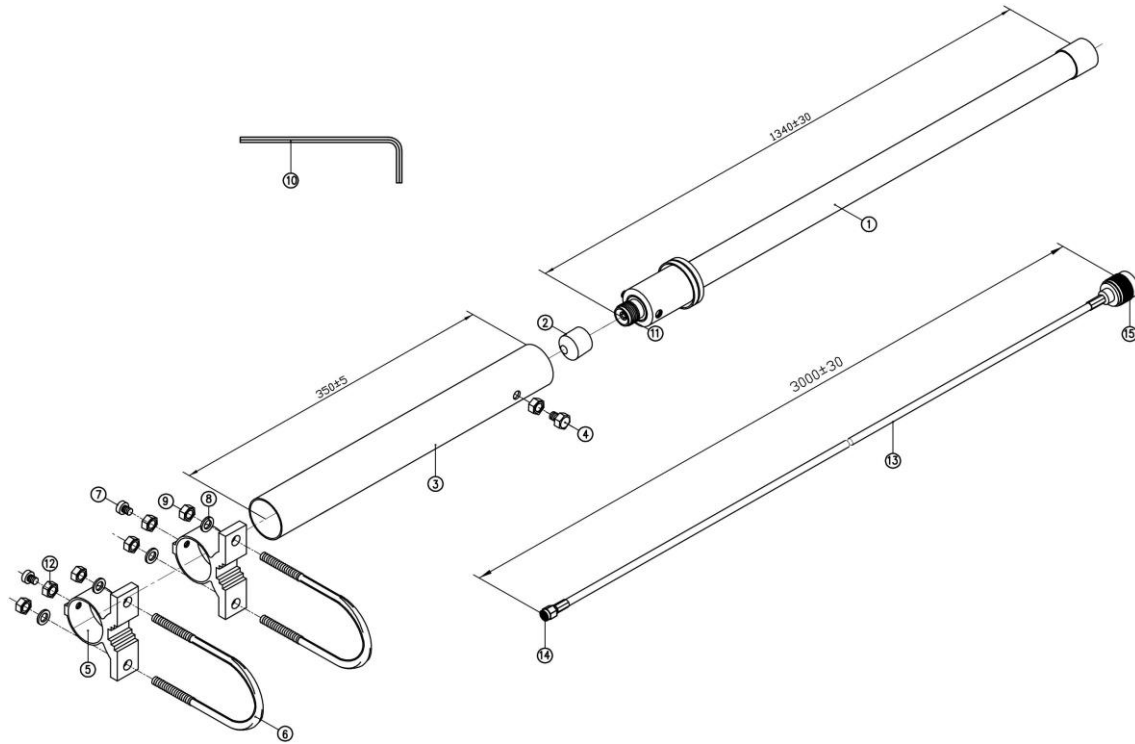

NO.	Name	Finish
1	Fiberglass body	White
2	Cap	Black
Mounting Accessories		
3	Mast	Aluminium
4 & 7	Screw	Stainless steel
5	Clamp	Aluminium
6	U-bolt	Stainless steel
8	Washer	Stainless steel
9 & 12	Hexagonal nut	Stainless steel
10	Hexagonal tool	Iron
11	N Female	Nickel plating
13	RG-58 cable	Black
14	SMA Male	Nickel plating
15	N Male	Nickel plating



3. Performance

3.1 Return Loss

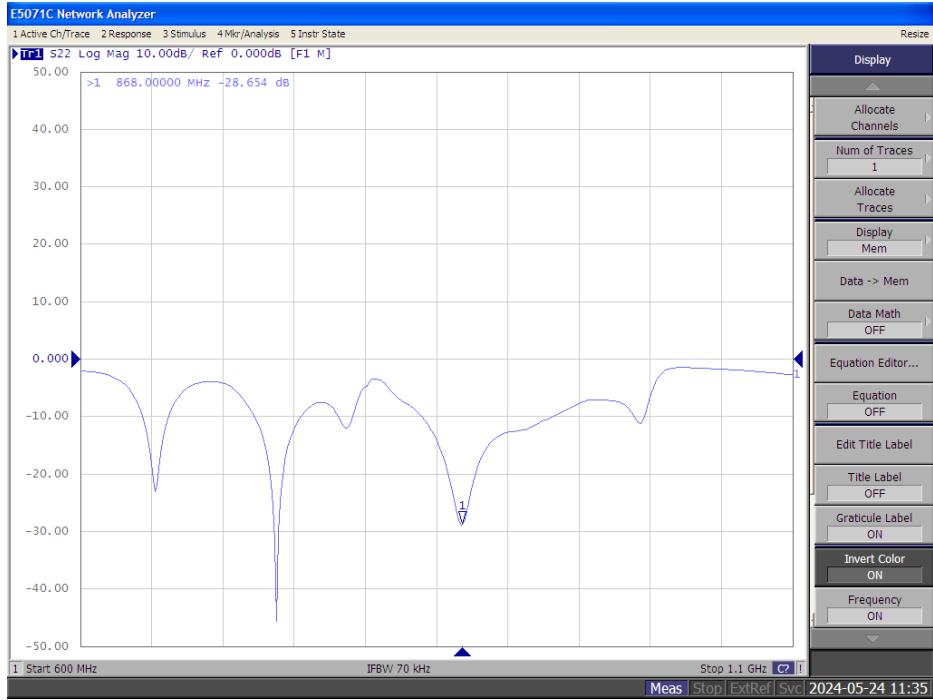

3.2 V.S.W.R.

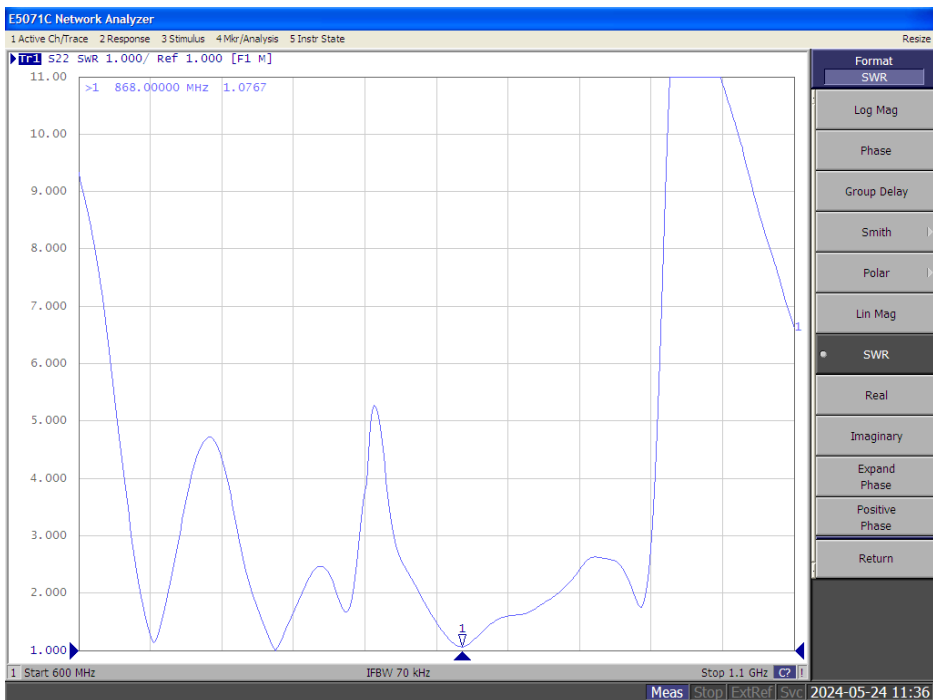



3.3 Smith Chart

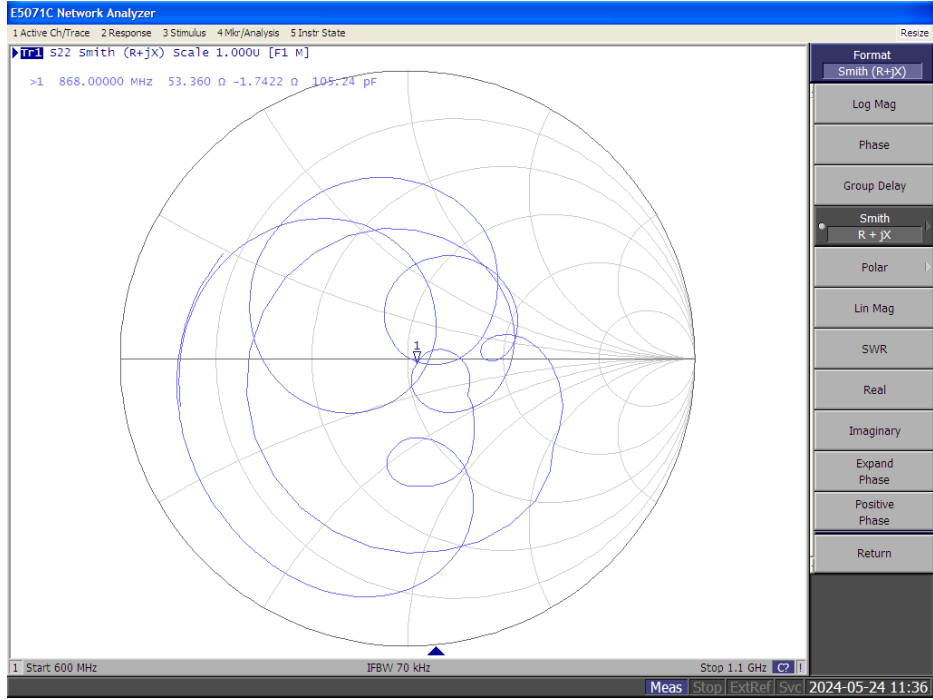



3.4 Efficiency & Gain

Frequency (MHz)	858	868	878
Efficiency (%)	55.34	63.39	61.94
Gain (dBi)	5.31	6.07	5.95

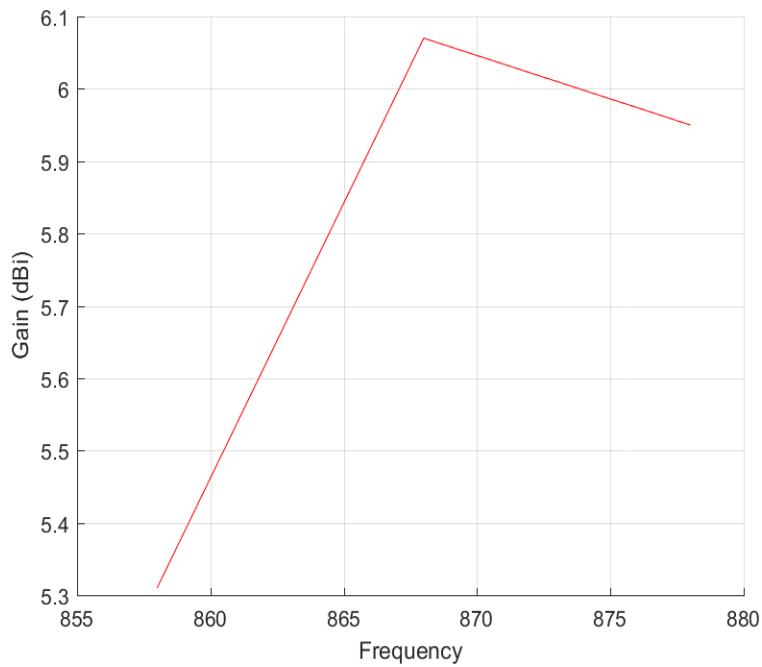
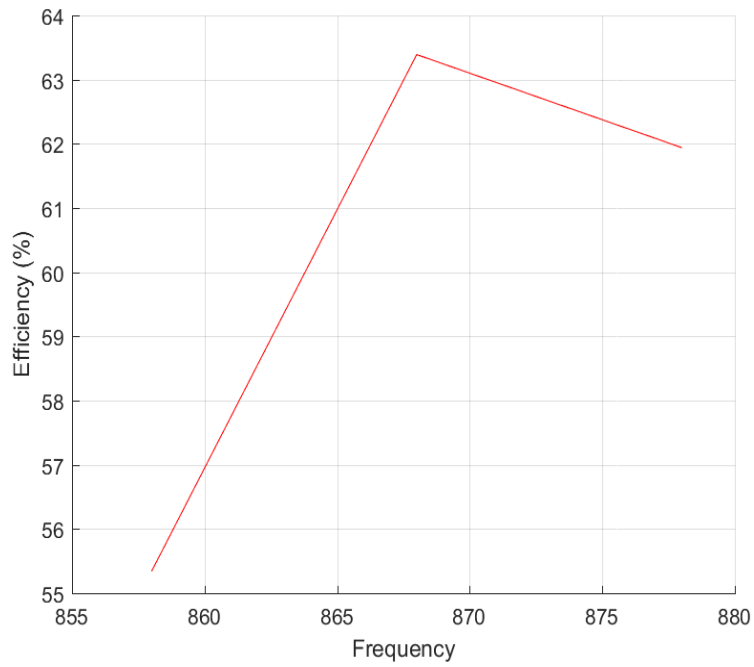

3.5 2D Radiation Pattern



Freq. / Chan.	Color
858MHz	Red
868MHz	Blue
878MHz	Green

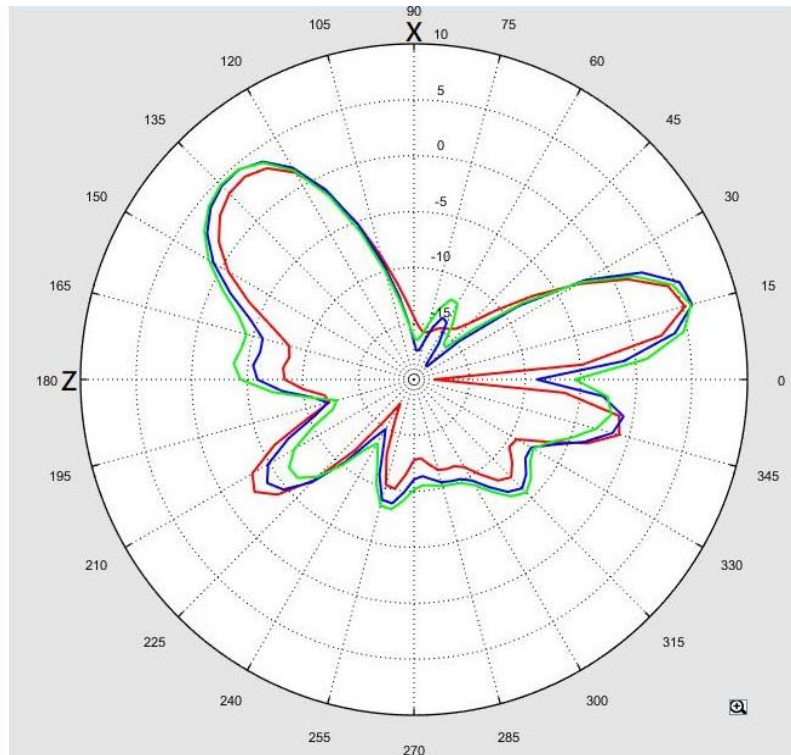

3.6 3D Radiation Pattern

Total_3D_Side View 1_858MHz

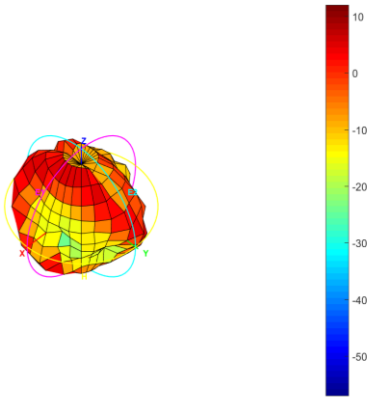

Total_3D_Side View 2_858MHz

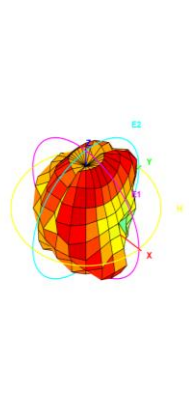

Total_3D_Side View 3_858MHz

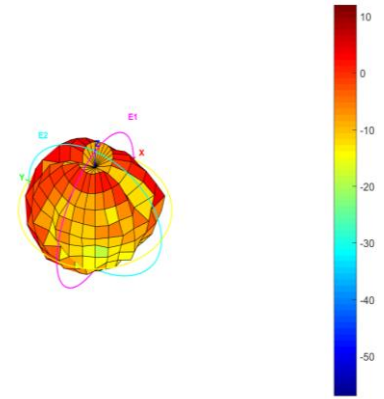

Total_3D_Side View 1_868MHz

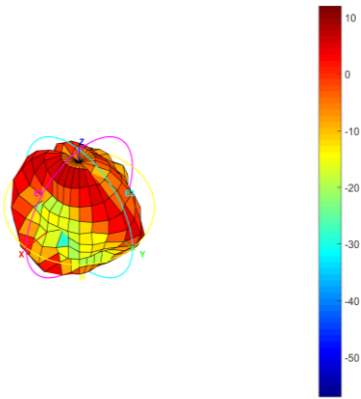

Total_3D_Side View 2_868MHz

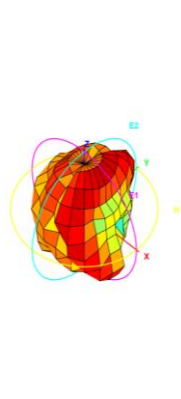

Total_3D_Side View 3_868MHz

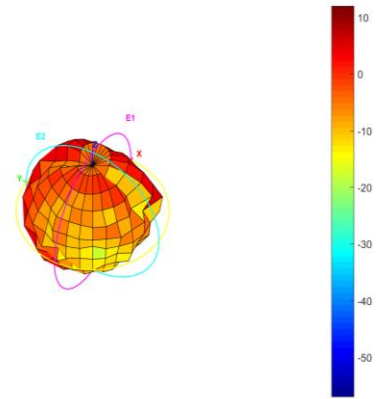

Total_3D_Side View 1_878MHz

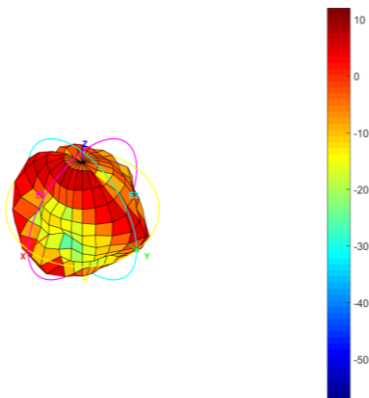

Total_3D_Side View 2_878MHz

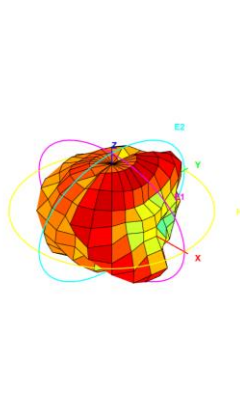

Total_3D_Side View 3_878MHz

