



SPECIFICATION

4G LTE Fiberglass Antenna



Model No. : AF01L-S9



1. General Description

1.1 Electrical Properties

Parameter	Description
Frequency Band	690~960/1710~2700 MHz
Nominal Impedance	50 Ω
Polarization	Vertical
V.S.W.R	<2.7 : 1
Max. Power	50 W

1.2 Mechanical Properties

Parameter	Description
Dimensions	756 mm \pm 10
Antenna Connector	180° N Female
Operating Temperature Range	-20°C~+60°C
Storage Temperature	-30°C~+70°C
Accessory	Mounting kit * 1

2. Appearance (Unit : mm)

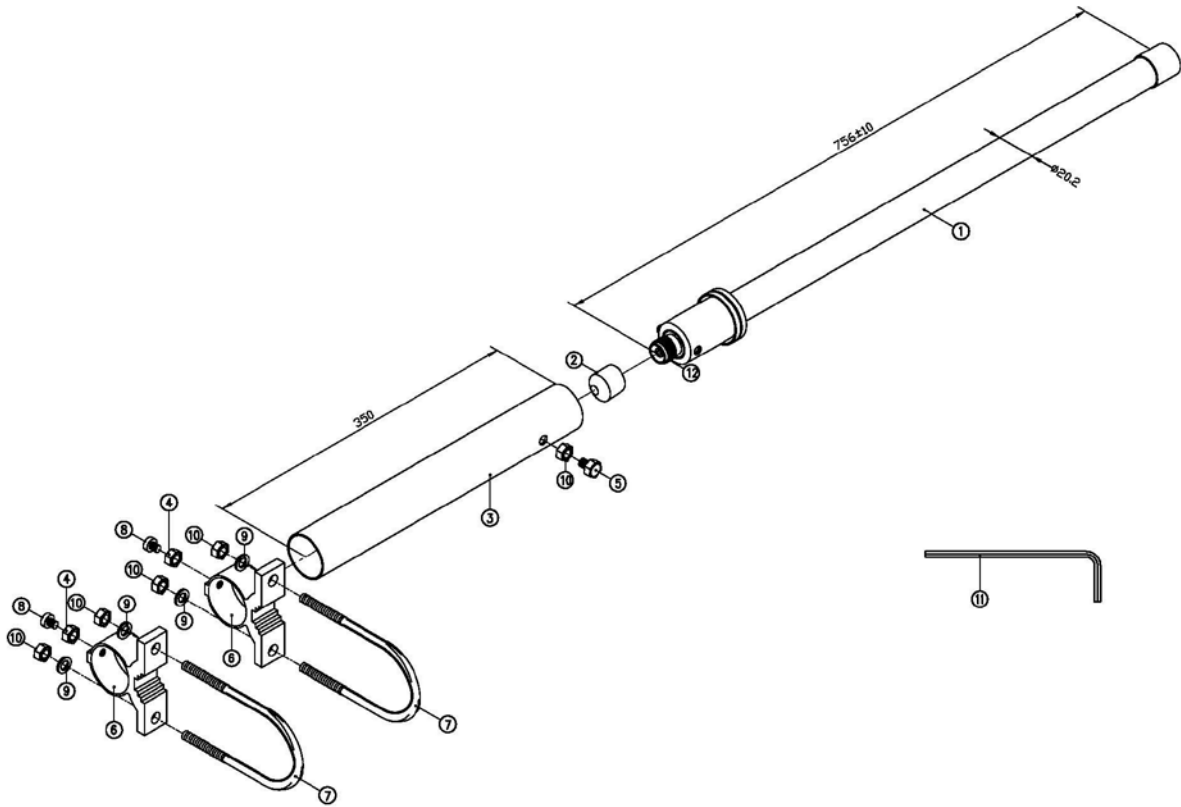

NO.	Name	Finish
1	Fiberglass body	White
2	Cap	Black
Mounting Accessories		
3	Mast	Aluminium
4 & 10	Hexagonal nut	Stainless steel
5 & 8	Screw	Stainless steel
6	Clamp	Aluminium
7	U-bolt	Stainless steel
9	Washer	Stainless steel
11	Hexagonal tool	Iron
12	N Female	Nickel plating



3. Performance

3.1 Return Loss

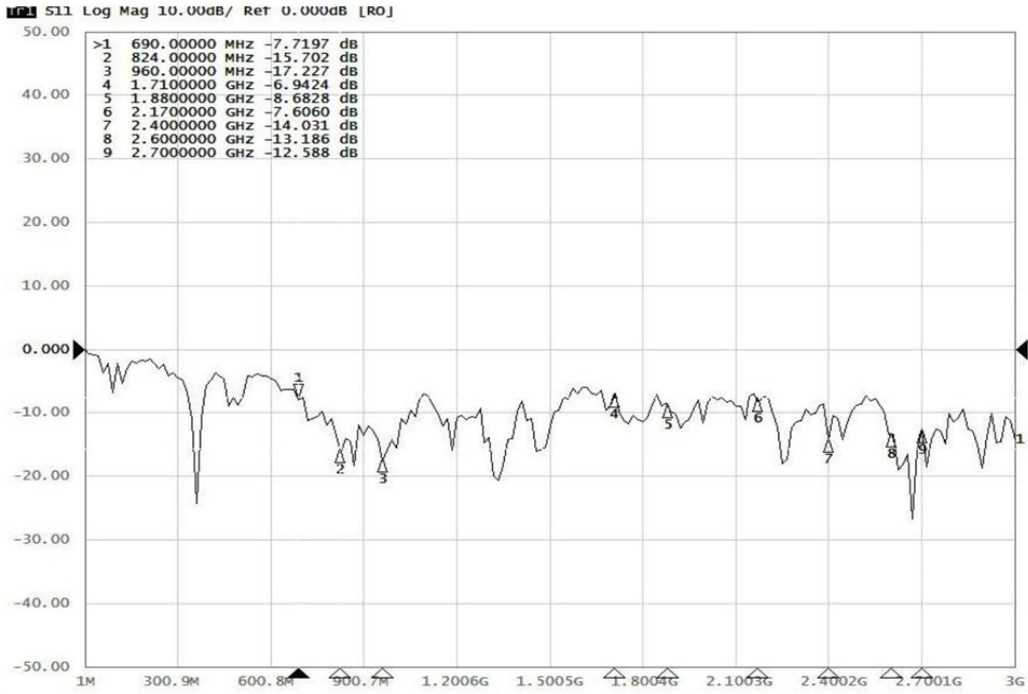

3.2 V.S.W.R.

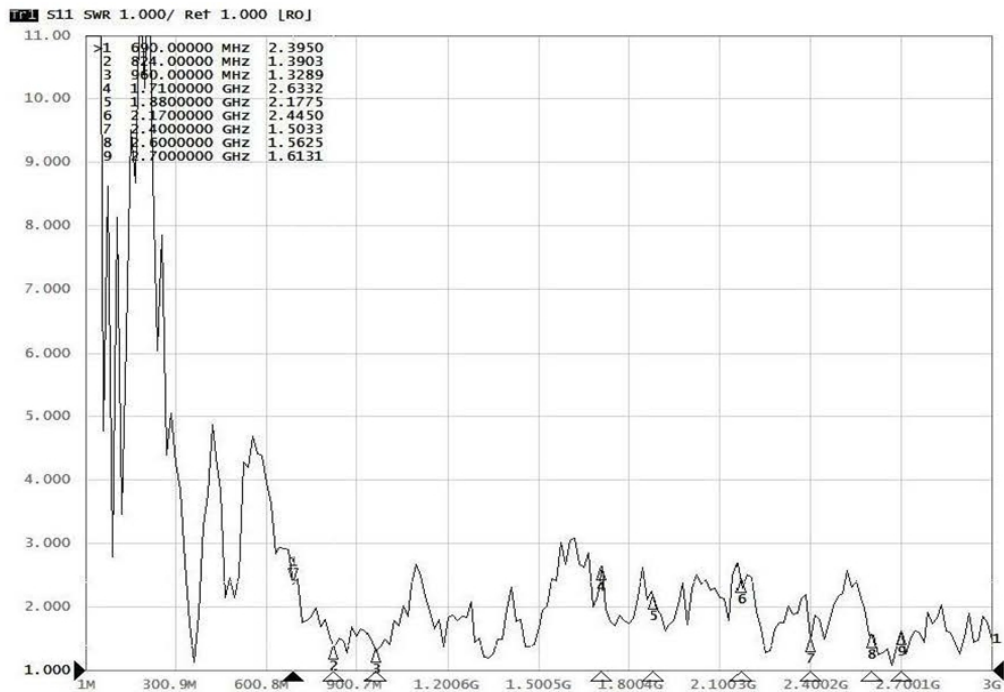



3.3 Efficiency & Gain

Frequency (MHz)	690	824	960	1710	1880	2170	2400	2600	2700
Efficiency (%)	58.83	65.77	85.23	66.83	64.42	47.42	86.1	58.75	95.72
Gain (dBi)	2.21	2.86	6.13	6.85	5.96	5.95	6.6	5.6	7.96

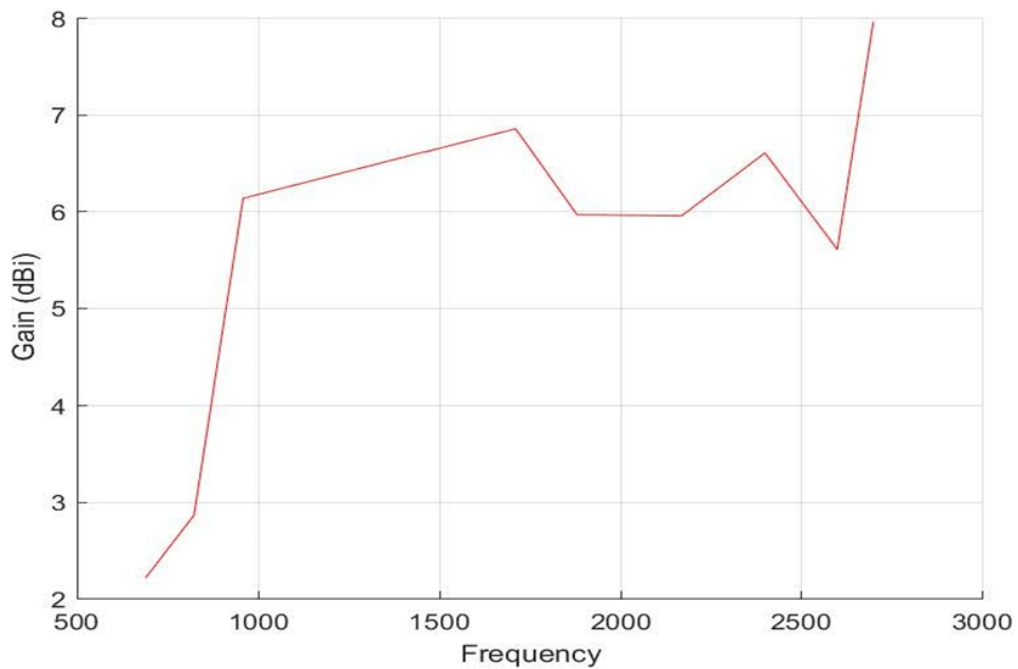
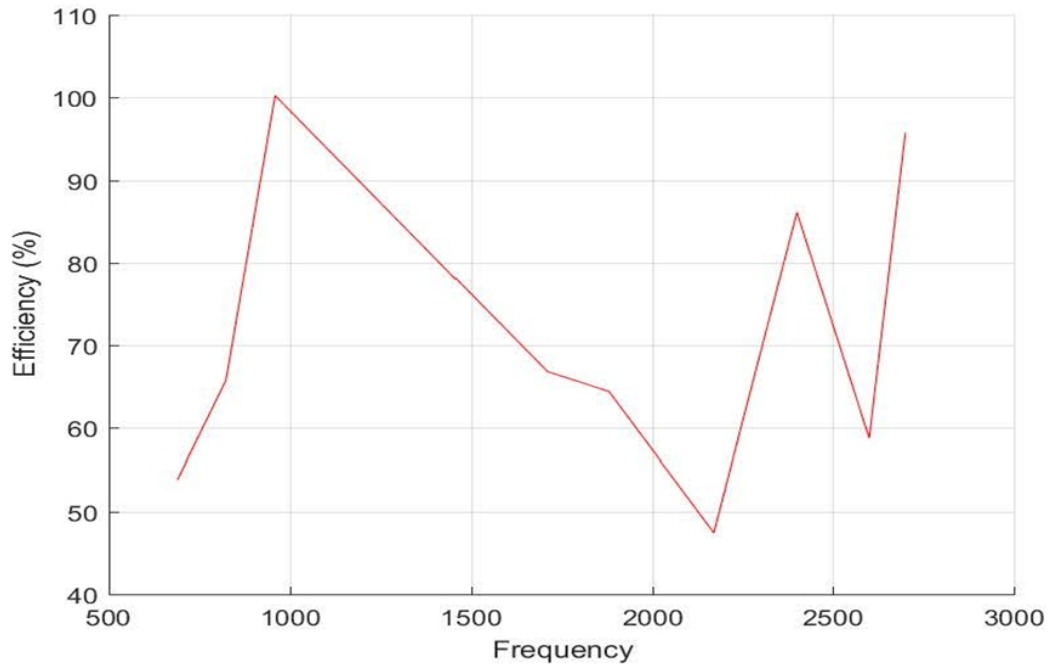



3.4 2D Radiation Pattern

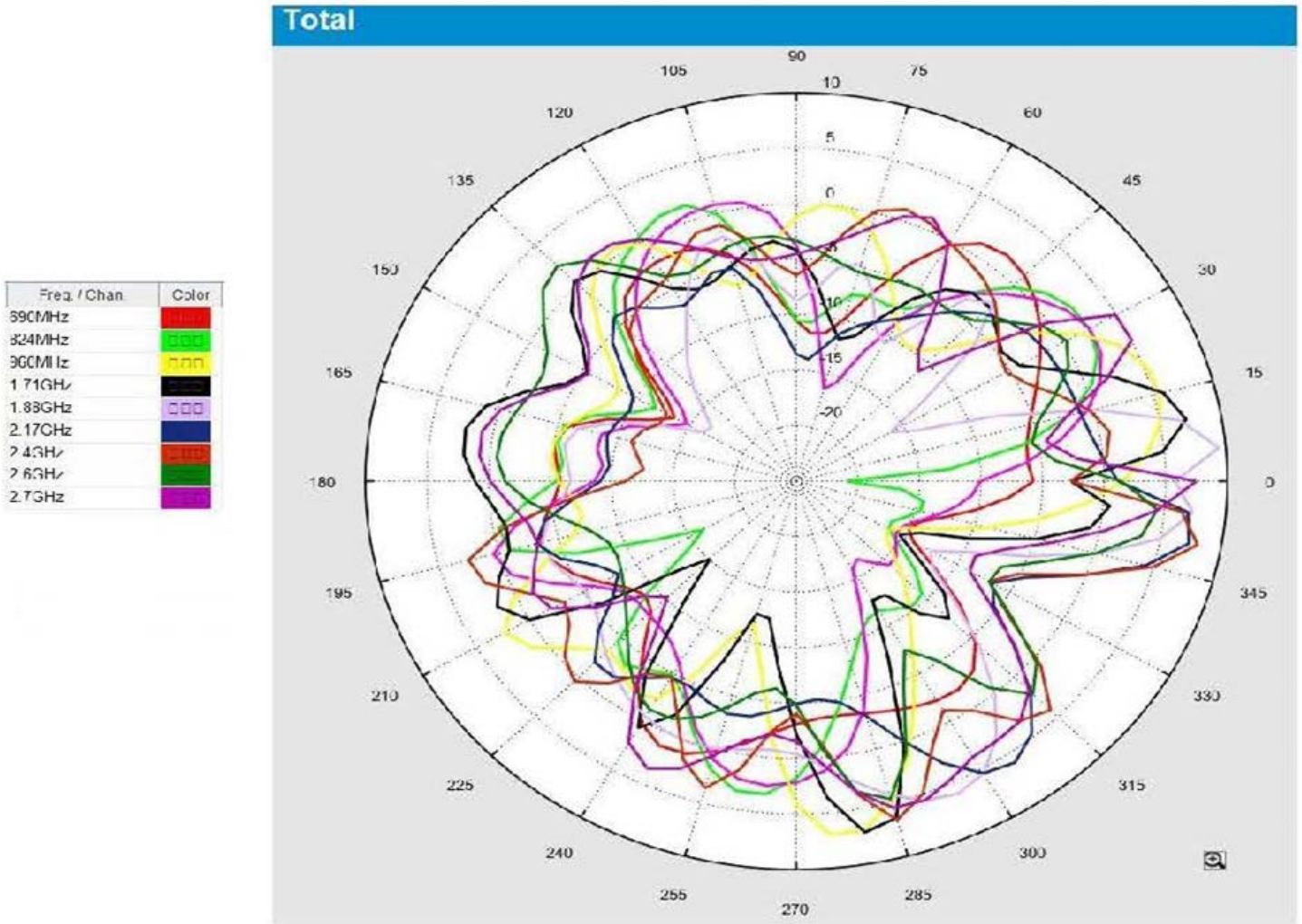

3.5 3D Radiation Pattern

Total_3D_Side View 1_690MHz

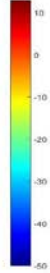
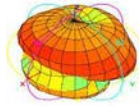

Total_3D_Side View 1_824MHz

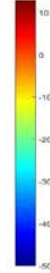
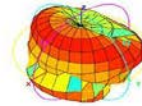

Total_3D_Side View 1_960MHz

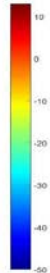
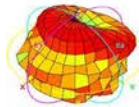

Total_3D_Side View 1_1.71GHz

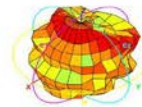

Total_3D_Side View 1_1.88GHz

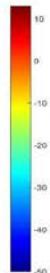
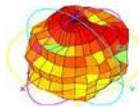

Total_3D_Side View 1_2.17GHz

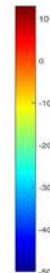
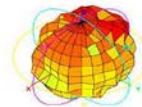

Total_3D_Side View 1_2.4GHz

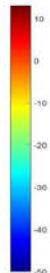
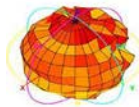

Total_3D_Side View 1_2.6GHz

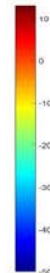
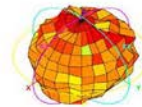

Total_3D_Side View 1_2.7GHz

