



# SPECIFICATION

## 4G LTE Fiberglass Antenna



**Model No. : AF01L-S9**



## 1. General Description

### 1.1 Electrical Properties

Parameter	Description
Frequency Band	690~960/1710~2170/2400~2700 MHz
Nominal Impedance	50 ohm
Polarization	Vertical
V.S.W.R	<2.7 : 1
Max. Power	50 W

### 1.2 Mechanical Properties

Parameter	Description
Antenna Dimensions	756 mm±10
Antenna Connector	180° N Female
Operating Temperature Range	-20°C~+60°C
Storage Temperature	-30°C~+70°C

## 2. Appearance (Unit : mm)

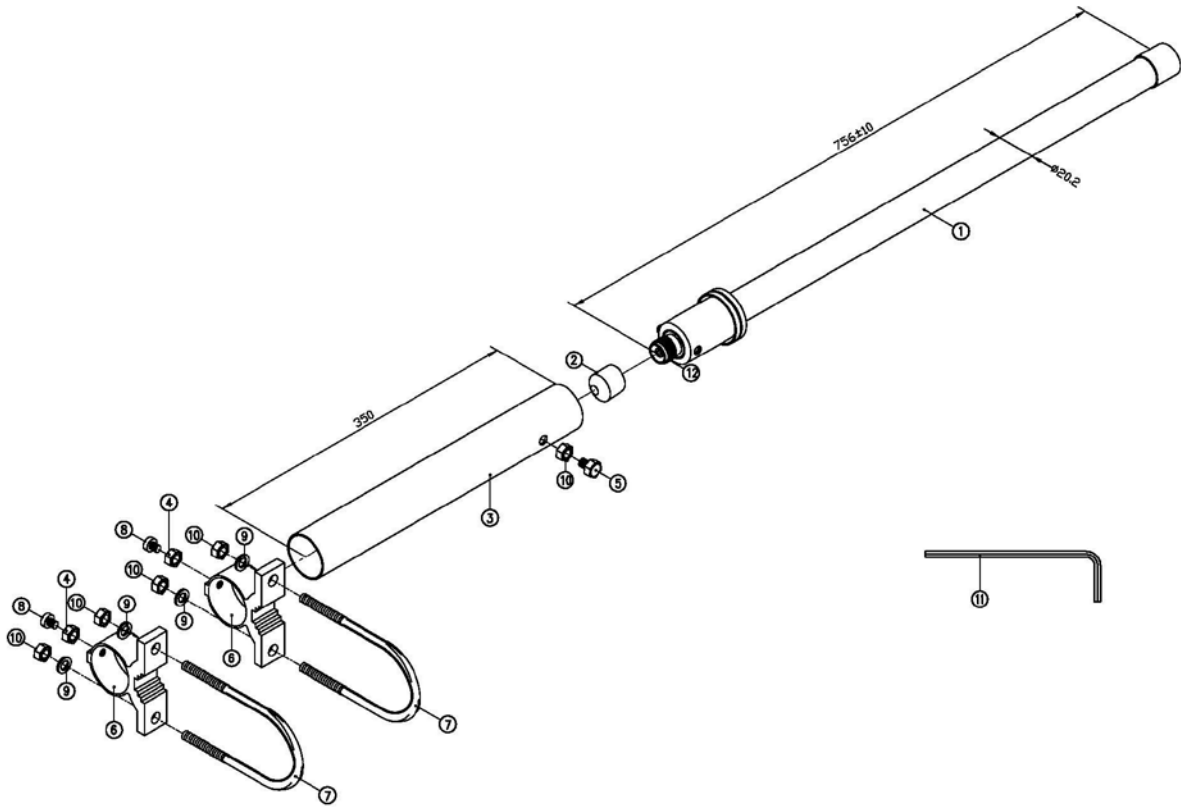

NO.	Name	Finish
1	Fiberglass body	White
2	Cap	Black
<b>Mounting Accessories</b>		
3	Mast	Aluminium
4 & 10	Hexagonal nut	Stainless steel
5 & 8	Screw	Stainless steel
6	Clamp	Aluminium
7	U-bolt	Stainless steel
9	Washer	Stainless steel
11	Hexagonal tool	Iron
12	N Female	Nickel plating



### 3. Performance

#### 3.1 Return Loss

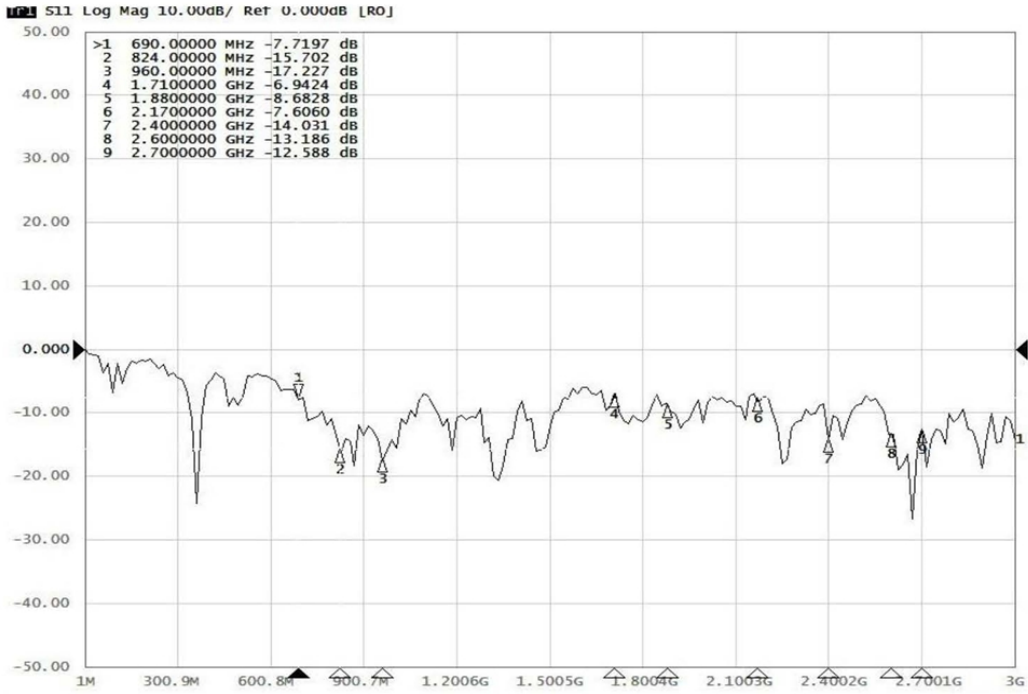

#### 3.2 V.S.W.R.

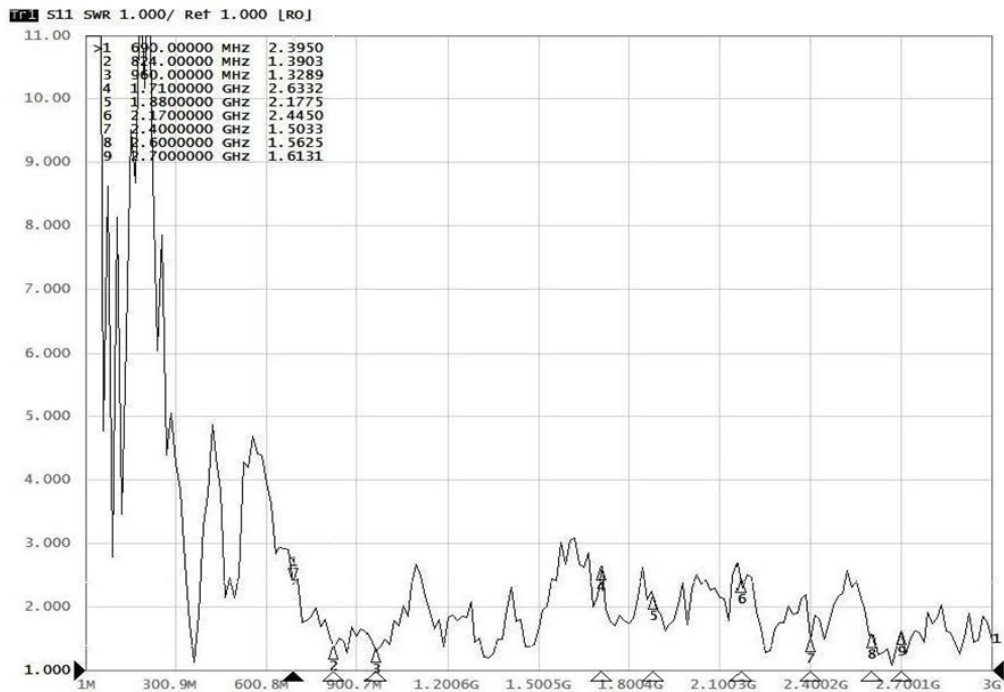



### 3.3 Efficiency & Gain

Frequency (MHz)	690	824	960	1710	1880	2170	2400	2600	2700
Efficiency (%)	58.83	65.77	85.23	66.83	64.42	47.42	86.1	58.75	95.72
Gain (dBi)	2.21	2.86	6.13	6.85	5.96	5.95	6.6	5.6	7.96

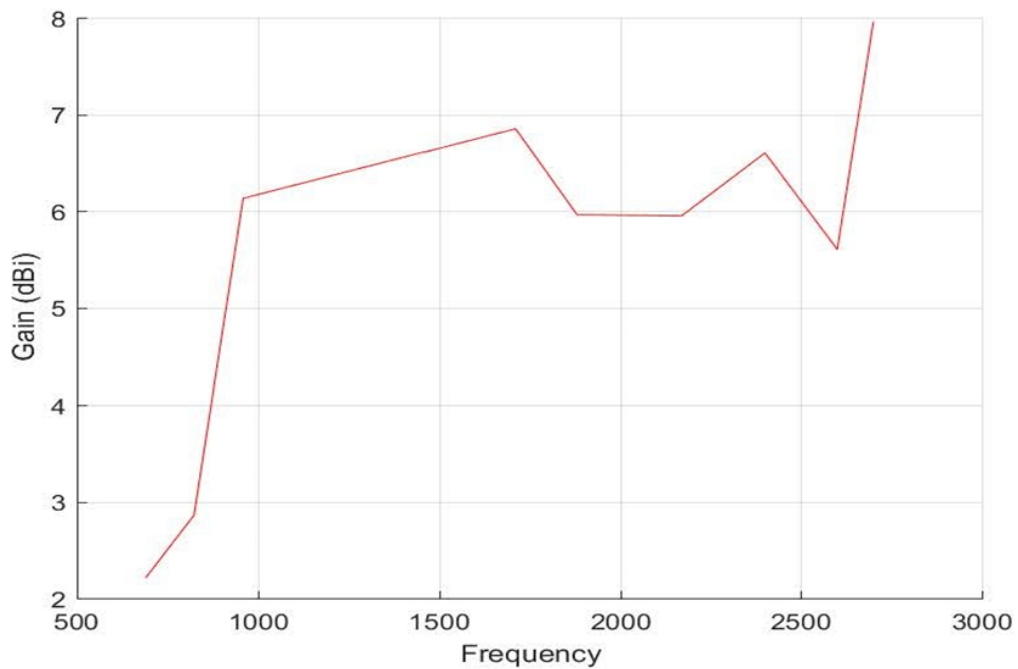
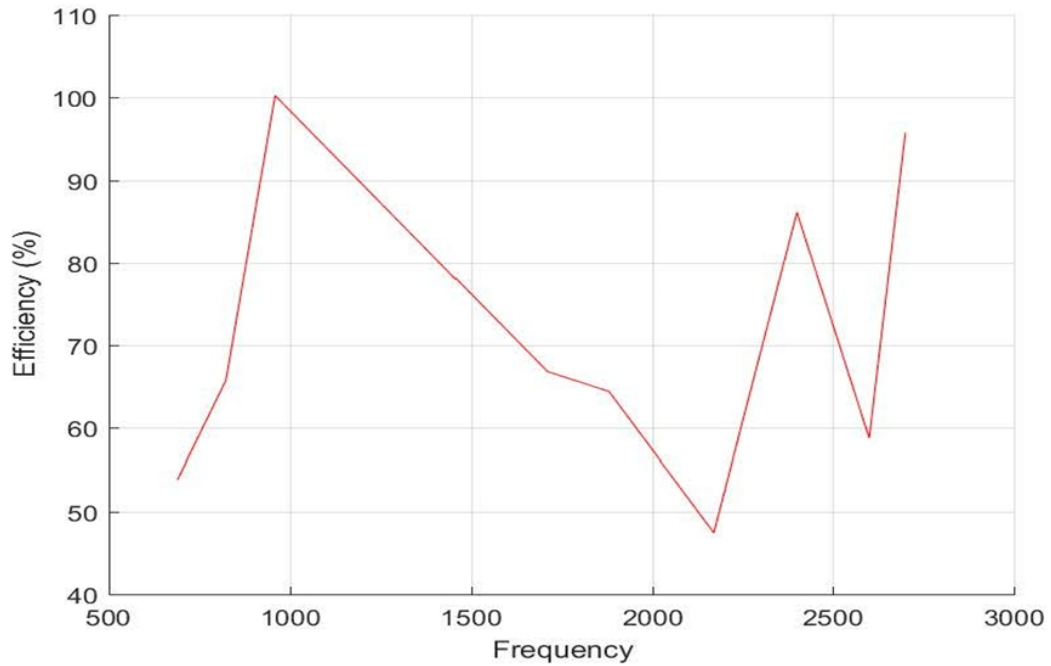



### 3.4 2D Radiation Pattern

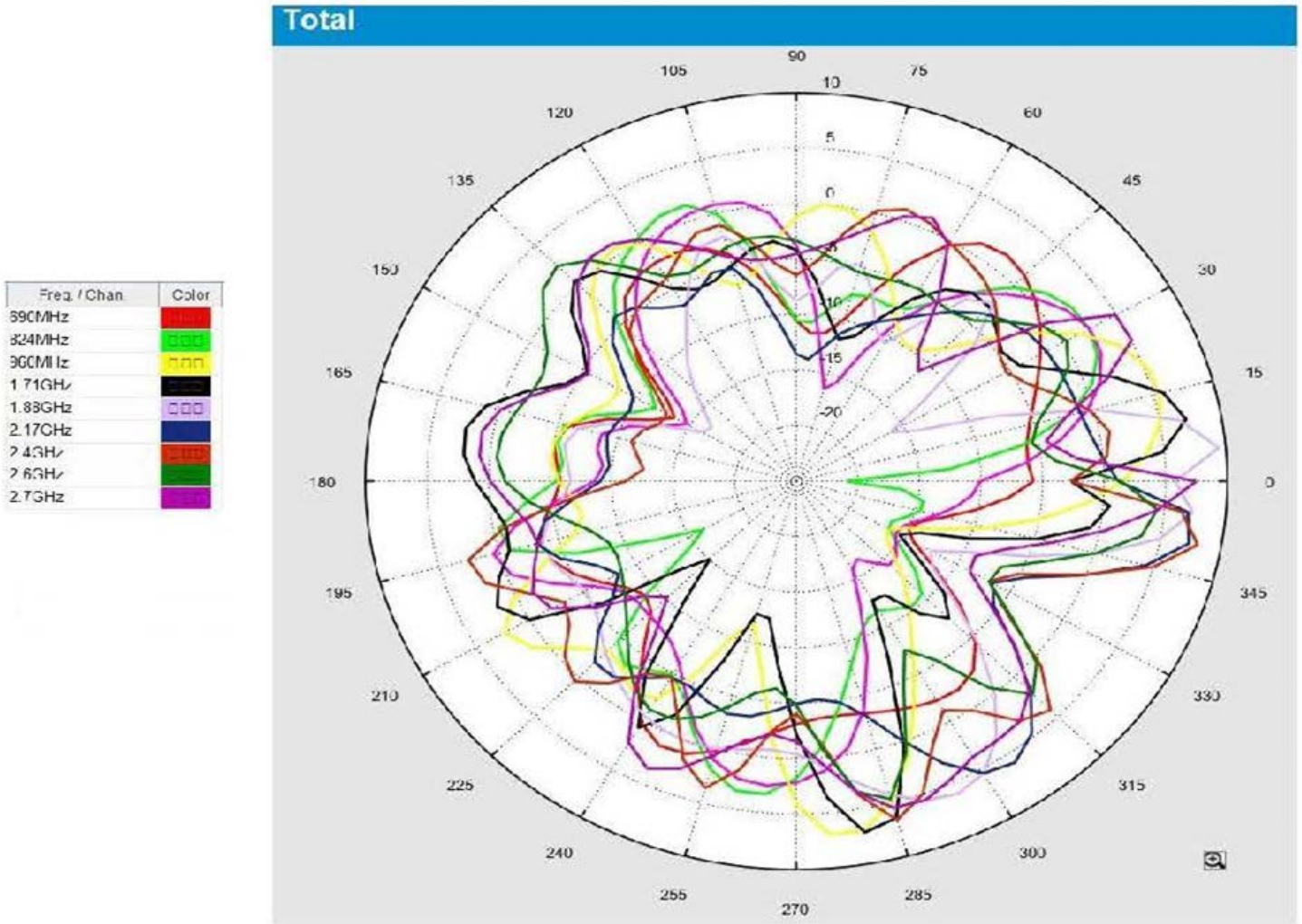

### 3.5 3D Radiation Pattern

Total\_3D\_Side View 1\_690MHz

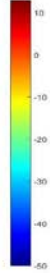
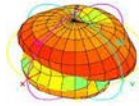

Total\_3D\_Side View 1\_824MHz

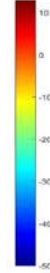
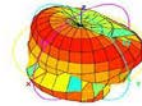

Total\_3D\_Side View 1\_960MHz

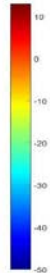
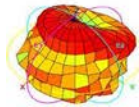

Total\_3D\_Side View 1\_1.71GHz

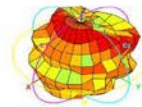

Total\_3D\_Side View 1\_1.88GHz

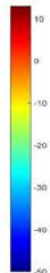
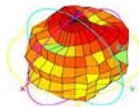

Total\_3D\_Side View 1\_2.17GHz

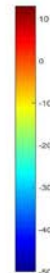
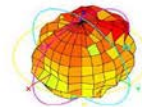

Total\_3D\_Side View 1\_2.4GHz

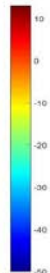
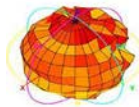

Total\_3D\_Side View 1\_2.6GHz

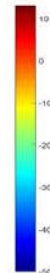
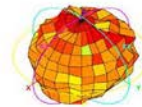

Total\_3D\_Side View 1\_2.7GHz

